





 **YANNICK COQUARD
CO-FOUNDER & FORMER
PROFESSIONAL RACER**

NORMANDIE, FRANKREICH

**YCF® ENTWICKELT UND FERTIGT SEIT 16 JAHREN
MOTORRÄDER. UNSERE MOTORRÄDER SIND AUF ALLE
FÄHIGKEITSSTUFEN ABGESTIMMT, VOM ANFÄNGER BIS
ZUM FORTGESCHRITTENEN. OB SIE ZUM SPIEL ODER AN
WETTBEWERBEN FAHREN, ES GIBT DAS RICHTIGE
MOTORRAD FÜR SIE! JEDES JAHR WIRD EINE NEUE REIHE
ZUVERLÄSSIGER, GÜNSTIGER UND LEISTUNGSSTARKER
MOTORRÄDER EINGEFÜHRT.**

**SO KÖNNEN SIE DEN GANZEN SPASS ERLEBEN, DEN MINI-
BIKES ZU BIETEN HABEN. 100 % DER YCF-PRODUKTE
WERDEN IN EIGENER HAND ENTWICKELT, ENTWICKELT
UND ENTWICKELT. DA SIE UNTER
WETTBEWERBSBEDINGUNGEN ENTWICKELT WERDEN,
NUTZT YCF® DIE NEUESTEN FORTSCHRITTE. DANKE, DASS
SIE SICH FÜR YCF® ENTSCHEIDEN HABEN.
VIEL SPASS BEI IHRER FAHRT!**

NORMANDY, FRANCE

**YCF® HAS BEEN DEVELOPING AND MANUFACTURING
MOTORCYCLES FOR THE PAST 16 YEARS. OUR BIKES ARE MATCHED
TO SKILL LEVELS FROM BEGINNERS TO ADVANCED. WHETHER YOU'RE
PLAY RIDING OR COMPETING, THERE'S A BIKE FOR YOU! EACH YEAR
A NEW RANGE OF RELIABLE, AFFORDABLE AND HIGH-PERFORMANCE
MOTORCYCLES ARE INTRODUCED.**

**ALLOWING YOU TO EXPERIENCE ALL THE FUN MINI BIKES HAVE TO
OFFER. 100% OF YCF PRODUCTS ARE DEVISED, DESIGNED AND
DEVELOPED IN-HOUSE. DUE TO BEING DEVELOPED UNDER
COMPETITION CONDITIONS, YCF® TAKE'S ADVANTAGE OF THE VERY
LATEST ADVANCES. THANK YOU FOR CHOOSING YCF®.**

ENJOY YOUR RIDE!



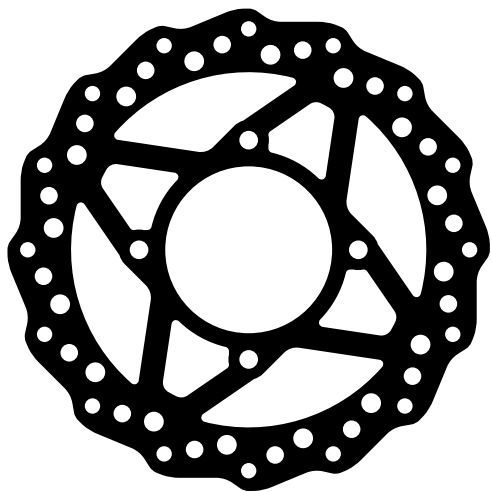

FACTORY PARTS



FOR 50 ONLY



FOR SUPERMOTO



FOR BIGY® ONLY



FOR GP ONLY



ARRO® TIRES



DAYTONA® ENGINES



ENGI® FORK



MIKUNI® CARBURETORS



KEIHIN® CARBURETORS



SPECIAL PARTS



NIBBI CARBURETORS®



KENDA® TIRES



DNM® SUSPENSIONS



TWINAIR® FILTERS





GAMME 2025 RANGE 2025

MINI YCF 12	10
MINI YCF 16	12
50AE	14
W50	16
LITE 88S	20
LITE 125	22
START 88SE	24
W88	26
START 125	28
START 125SE	30
PILOT 125	32
PILOT 150E	34
FACTORY 150 SP2	36
FACTORY 190 SP3 DAYTONA®	38
BIGY 125	40
BIGY 150	42
BIGY 150E FACTORY XL	44
BIGY 190 FACTORY DAYTONA® XL	46
SM 125	48
SM 155	50
SM 190 DAYTONA®	52
GP 124	54
GP 157	56
GP 187 DAYTONA®	58
PIÈCES GP/ GP PARTS	60
PADDOCK/ PADDOCK	66
TEXTILES/ APPAREL	68

ACCESSOIRES PLASTIQUES PLASTIC PARTS

KITS DÉCO/ GRAPHIC KITS	70
PERSONNALISATION/ CUSTOMIZATION	75
KITS PLASTIQUES/ PLASTIC KITS	76

PIÈCES MOTO CYCLE PARTS

GUIDONS/ HANDLEBARS	84
POIGNÉES/ LEVERS	86
FOURCHES/ FORKS	88
CADRES/ FRAMES	91
SELLES/ SEATS	92
RÉSERVOIRS/ FUEL TANKS	93
FREINS/ BRAKES	94
BRAS OSCILLANTS/ SWING ARMS	102
AMORTISSEURS/ SHOCK ABSORBERS	104
ROUES/ WHEELS	105
JANTES & MOYEUX/ RIMS & HUBS	105
PNEUS/ TIRES	112
REPOSE-PIEDS & SABOTS/ FOOT PEGS & SKID PLATES	114
SÉLECTEURS/ SHIFT LEVERS	115
KITS CHAÎNES/ SPROCKET KITS	116
OUTILS/ TOOLS	118
ENGI®/ ENGI®	120
PIÈCES SPÉCIALES SUPERMOTARD/ SUPERMOTO FACTORY SPECIAL PARTS	122

PIÈCES MOTEUR ENGINE PARTS

MOTEURS DAYTONA®/ DAYTONA® ENGINES	126
MOTEURS/ ENGINES	126
KITS MOTEUR/ ENGINE KITS	128
EMBRAYAGE/ CLUTCH	131
CARBURETEURS/ CARBURETORS	133
FILTRES À AIR/ AIR FILTERS	135
ÉCHAPPEMENTS/ EXHAUSTS	136
FILTRES & RADIATEURS/ FILTERS & COOLERS	139
ALLUMAGE/ IGNITION	140
PIÈCES RACING DAYTONA®/ DAYTONA® RACING PARTS	142
PIÈCES D'ORIGINE DAYTONA®/ DAYTONA® GENUINE PARTS	143

INDEX - FRENCH 2025

A

AIGUILLE DE CARBURATEUR.....	133
ALLUMAGE.....	140/142
AMORTISSEUR.....	104/121
ANTIPARASITE.....	141
ARBRE DE BOÎTE.....	130
ARRACHE VOLANT.....	118
ATTACHE RAPIDE DE CHAÎNE.....	116
ATTACHE SILENCIEUX.....	136/137
AXE DE BRAS OSCILLANT.....	103
AXE DE ROUE.....	109
AXE DE PLAQUETTE DE FREIN.....	94

B

BÂCHE MOTO.....	66
BAGUE DE FOURCHE.....	88/120
BANDEROLE.....	66
BANNER.....	66
BARRE DE REPOSE-PIED.....	114
BATTERIE.....	140
BAVETTE D'AMORTISSEUR.....	104
BÉQUILLE.....	67/91
BOB.....	69
BOBINE D'ALLUMAGE.....	140
BOÎTE À AIR.....	135
BONNET.....	68
BOUCHON DE CARTER D'ALLUMAGE.....	128
BOUCHON DE RÉSERVOIR.....	93
BOUCHON DE VALVE.....	112
BOUCHON DE VIDANGE.....	139
BOUCLE ARRIÈRE.....	91
BOUGIE.....	141
BRAS OSCILLANT.....	102
BRIDE DE POT.....	136

C

CÂBLE DE GAZ ET D'EMBRAYAGE.....	87
CÂBLE DE PÉDALE DE FREIN.....	98
CACHE CULASSE.....	142
CACHE FILTRE À HUILE.....	142
CACHE POUSSIÈRE.....	120
CADRE.....	91
CAGE DE FILTRE À AIR.....	134
CALE PLASTIQUE DE PIPE D'ADMISSION.....	134

CALE DE PONTET DE GUIDON 20 mm.....	89
CAOUTCHOUC D'EMBRAYAGE.....	87
CAOUTCHOUC DE LEVIER DE FREIN.....	87
CAOUTCHOUC D'ÉTRIER.....	97
CAPOT DE MAÎTRE-CYLINDRE FREIN.....	101
CARBURATEUR.....	133
CARTER D'ALLUMAGE.....	128/129
CARTER D'EMBRAYAGE.....	131
CASQUETTE.....	68
CDI.....	140
CERCEAU DE ROUE.....	108/109
CHAÎNE.....	116
CHAÎNE DE DÉMARREUR.....	142
CHAÎNE DE DISTRIBUTION.....	128/142
CHAISE PLIABLE.....	66
CHAMBRE À AIR.....	112
CHAPE DE MAÎTRE-CYLINDRE.....	98
CHAPEAU.....	69
CHARGEUR BATTERIE.....	140
CLÉ À BOUGIE.....	118
CLÉ À RAYON.....	118
CLOCHE D'EMBRAYAGE.....	132
COCOTTE D'EMBRAYAGE.....	87
COLLECTEUR.....	138
COMPTEUR D'HEURES.....	141
CONTACTEUR À CLÉ.....	140
COUPE CIRCUIT.....	141
COURONNE.....	116/117
COURONNE D'EMBRAYAGE.....	131
COUVERTURE CHAUFFANTE (PAIRE).....	113
COUVRES RAYONS.....	109
COUVRE RÉSERVOIR.....	93
CULASSE.....	130
CYLINDRE.....	130

D

DAYTONA® (PIÈCES).....	142-147
DÉRIVE CHAÎNE.....	118
DÉMONTE PNEU.....	118
DÉMONTE NOIX EMBRAYAGE.....	118
DÉCO DE CADRE.....	70
DIABOLO CNC.....	102
DISQUE DE FREIN.....	100
DISQUE D'EMBRAYAGE.....	131
DONUTS.....	87
DURITE D'ESSENCE.....	93
DURITE DE FREIN.....	96/97
DURITE D'HUILE RADIATEUR.....	139

E

ÉCHAPPEMENT.....	137-138
ÉCHAPPEMENT COMPLET.....	137
ÉCROU DE BÉQUILLE.....	91
ÉCROU DE COLONNE DE DIRECTION.....	90
EMBOUT DE PÉDALE DE FREIN.....	98
EMBOUT DE POT.....	136
EMBOUT DE MAÎTRE-CYLINDRE FREIN.....	98
EMBRAYAGE COMPLET.....	131
ENGI® (PIÈCES).....	120/121
ENTRETOISE D'AMORTISSEUR.....	104
ENTRETOISE DE ROUE.....	110
ÉPURATEUR D'HUILE.....	139
ÉTRIER DE FREIN.....	94/96/97

F

FAISCEAUX ÉLECTRIQUES.....	140
FEUTRINE.....	66
FILTRE À AIR.....	135
FILTRE À HUILE.....	139
FOND DE JANTE.....	112
FOURCHE.....	88/120
FOURCHETTE DE BOÎTE.....	130
FREIN ARRIÈRE.....	94/95/97
FREIN AVANT.....	94/95/96
FREIN FILET.....	118

G

GARDE BOUE ARRIÈRE.....	78/79
GARDE BOUE AVANT.....	76/79/81
GICLEUR.....	133
GRIPSTER.....	109
GUIDE DE CHAÎNE.....	103
GUIDON.....	85

H

HUBLLOT À HUILE.....	139
----------------------	-----

J

JANTES.....	108-109
JAUGE À HUILE.....	139
JEU DE CALES MOTEUR.....	118
JEU DE RAYONS.....	109
JOINT DE BOUCHON DE RÉSERVOIR.....	93
JOINT DE CARTER D'EMBRAYAGE.....	132
JOINT DE COLONNE DE DIRECTION.....	90
JOINT DE CUVE POUR CARBURATEUR.....	133
JOINT PAPIER DE PIPE D'ADMISSION.....	134
JOINT DE POT.....	136

JOINT DE QUEUE DE SOUPAPE.....	130
JOINT SPY DE FOURCHE	88/120
JOINT SPY DE TIGE COMMANDE D'EMBRAYAGE	132
JOINT SPY DE KICK	132
JOINT SPY DE PSB	132
JOINT SPY DE ROUE.....	109
JOINT SPY DE SÉLECTEUR	132

K

KICK	115
KIT 212cc	142
KIT ARBRE À CAMES RACING	132/142
KIT DÉCO	70-74
KIT DÉCO DE CADRE	70
KIT DÉPART	120
KIT FREIN	94/95/96/97
KIT LAMPE	82
KIT PISTON	129
KIT PLASTIQUE	76-81
KIT RABASSE.....	104
KIT RÉFECTION D'AMORTISSEUR	121
KIT RÉFECTION ENTRETOISE AXE AMORTISSEUR ...	121
KIT RÉFECTION DE FOURCHE.....	88
KIT RONDELLE CNC	82
KIT ROUE SUPERMOTARD	105
KIT ROULEMENT DE COLONNE DE DIRECTION	90
KIT STABILISATEUR	18
KIT SUPERMOTARD	114/122
KIT VIS.....	82/100/117/133

L

LAINÉ DE ROCHE.....	136
LEVIER D'EMBRAYAGE	86/87
LEVIER DE FREIN	86/87/94

M

MAÎTRE-CYLINDRE	94/96/97
MANCHON DE BOÎTE À AIR	134
MANCHON DE PIPE D'ADMISSION	134
MOTEUR	126-127
MOUSSE DE GUIDON	84
MOYEU	110

N

NUMÉROS	75
---------------	----

O

ORIFLAMME	66
QUIE DE RADIATEUR	76/79
OUTILLAGE.....	118/120

P

PARAPLUIE	68
PASSE DURITE DE FREIN AVANT	82
PATTE DE CADRE	91
PATTE DE FREIN CNC.....	94
PATIN DE BRAS OSCILLANT	103
PATIN DE CHAÎNE	103
PÉDALE DE FREIN	98
PIÈCES D'ORIGINE DAYTONA®.....	141-147
PIÈCES GP	60-64
PIGNON	130/132
PIGNON DE CLOCHE D'EMBRAYAGE	132
PIGNON DE SORTIE DE BOÎTE	116
PIPE D'ADMISSION	134/142
PISTON	129/142
PLANCHE DE STICKERS.....	75
PLAQUE AVANT.....	76/80
PLAQUES LATÉRALES.....	77/80
PLAQUE PHARE	82
PLAQUETTES DE FREIN	100
PLATEAU D'ALLUMAGE.....	140
PNEU.....	112-113
POCHETTE DE JOINTS	130
POIGNÉE DE GAZ	86
POIGNÉES CAOUTCHOUC.....	87
POIGNÉES DE PLAQUES LATÉRALE.....	77/80
POINTEAU DE CARBURATEUR.....	133
POLO	68
PONTET DE GUIDON	89
PROTECTION DE FOURCHE.....	78
PROTECTION DE PIGNON SORTIE BOÎTE.....	117
PROTECTION SM	114
PROTÈGE DISQUE ARRIÈRE	103
PROTÈGE DISQUE AVANT	82
PROTÈGE LEVIER	84
PROTÈGE MAIN	84
PROTÈGE MAÎTRE-CYLINDRE.....	98

R

RAYONS	109
RADIATEUR D'HUILE	139
RÉGULATEUR DE TENSION	140
RELAIS DE DÉMARREUR	140
REPOSE PIED.....	114
RÉSERVOIR	93
RÉSERVOIR RÉCUPERATEUR HUILE/ ESSENCE	114
RESSORT D'AMORTISSEUR	104
RESSORT DE BÉQUILLE	91
RESSORT DE KICK.....	115

RESSORT DE PÉDALE DE FREIN.....	98
RESSORT DE POT	136/137
RESSORT POUR ÉTRIER RADIAL.....	94
ROBINET D'ESSENCE	93
ROUES.....	18/105-108
ROULEMENT DE COLONNE DE DIRECTION.....	90
ROULEMENT DE ROUE	109
ROULEMENT DE BRAS OSCILLANT	103
ROULETTE DE CHAÎNE.....	103
RUBALISE DE TERRAIN	66

S

SABOT	114/115
SAC À DOS/TRANSPORT	69
SEGMENT	129
SÉLECTEUR	115
SELLE.....	92
SILENCIEUX	137
SOUPAPE.....	130
STARTER AU GUIDON	134
SUPPORT DE COMPTEUR D'HEURES	141
SURFILTRE À AIR	134
SWEAT	68

T

TAPIS	67
TÉ DE FOURCHE	88/89
TEESHIRT.....	68
TENDEUR DE CHAÎNE	117
TIGE DE COMMANDE D'EMBRAYAGE	132
TONNELLE	66
TRÉPIED.....	67

V

VALVE COUDÉE 90°.....	105
VALVE PRISE AIR	93
VILEBREQUIN.....	129
VIS DE BÉQUILLE.....	91
VIS DE COURONNE	117
VIS DE CUVE.....	133
VIS DE DISQUE	100
VIS DE RALENTI.....	133
VIS ET ÉCROU TENDEUR DE CHAÎNE	103
VIS DE PLAQUETTE DE FREIN	100
VIS DE RÉGLAGE DE LA POIGNÉE DE GAZ	86
VIS RENFORCÉES POUR MOTEUR	91
VIS DE RICHESSE	133
VISSERIE	82/91/117

INDEX - ENGLISH

2025

A

AIR FILTERS.....	135
AIR FILTER CAGE	134
AIR FILTER PROTECTION.....	134
AIRBOX CAPS.....	135
AIRBOX RUBBER SLEEVES.....	134
AIRBOXES.....	135
APPAREL.....	68
AXLES.....	109

B

BACKPACK.....	69
BANNER ROLL.....	66
BANNERS.....	66
BAR END CAPS.....	87
BAR MOUNTS.....	89
BATTERY CHARGER.....	140
BEANIE.....	68
BEARINGS.....	103/109
BIKE STANDS.....	67
BOLT KIT FOR AXLE BLOCK.....	103
BOLT KIT FOR BRAKE DISC.....	100
BOLT KITS FOR FUEL TANK.....	82
BOLT KIT FOR PLASTIC KIT.....	82
BOLT KIT FOR SEAT.....	82
BOLT KIT FOR SPROCKET.....	117
BRAKE CALIPERS.....	94-97
BRAKE CLEVIS.....	98
BRAKE DISCS.....	100
BRAKE GUARDS (FRONT).....	82
BRAKE HOSES.....	74
BRAKE LEVERS.....	86/87/94
BRAKE LEVER RUBBERS.....	87
BRAKE MASTER CYLINDERS.....	94/96/97
BRAKE PADS.....	100
BRAKE PEDALS.....	98
BRAKE RESERVOIR COVER.....	101
BRAKE SYSTEMS (COMPLETE).....	94-97
BUCKET HAT.....	69

C

CAMSHAFT KIT.....	132/142
CAP BIG VIEW HOLE.....	128
CAPS.....	68

CARBURETOR FLOAT.....	133
CARBURETORS.....	133
CARBURETOR BOOT.....	134
CATCH CAN.....	114
CDI.....	140
CHAIN GUIDES.....	103
CHAIN LINKS.....	118
CHAIN SLIDERS.....	103
CHAIN TENSIONERS.....	103
CHAIN TOOLS.....	118
CHAINS.....	116
CHOKE LEVER.....	134
CLUTCH ASSEMBLY.....	131
CLUTCH BRACKET.....	87
CLUTCH CABLES.....	87
CLUTCH CONTROL OIL SEAL.....	132
CLUTCH COVER.....	131
CLUTCH FOR KICKSTARTER.....	131/132
CLUTCH LEVER RUBBERS.....	87
CLUTCH LEVERS.....	86/87
CLUTCH SPROCKET.....	130/131
CLUTCH TOOLS.....	118
COUNTERSHAFT SPROCKET.....	116
COUNTERSHAFT SPROCKET GUARD.....	117
CRANKSHAFTS.....	129
CUSTOM NUMBERS.....	75
CYLINDERS.....	130

D

DAYTONA ENGINE 212 KIT.....	142
DAYTONA® PARTS.....	141-147
DISCS.....	100
DISC GUARD.....	82/103
DUST SEALS.....	109

E

ENGI®.....	120-121
ENGINE ADJUSTMENT GAUGES.....	118
ENGINE BASH PLATE STEEL.....	114
ENGINE KITS.....	128/142
ENGINE REINFORCED BOLT SETS.....	91
ENGINES (COMPLETE).....	126-127
EXHAUSTS.....	137-138
EXHAUST END.....	136
EXHAUST PIPE.....	136/137
EXHAUST SPRING.....	136/137
EXHAUST VALVE.....	130

F

FENDER.....	76/79/81
-------------	----------

FILTER.....	135
FLAGS (PROMOTIONAL).....	66
FLYWHEEL REMOVER.....	118
FOAM AIR FILTER.....	135
FOLDABLE LEVERS.....	86
FOLDING CHAIR.....	66
FOOT PEG MOUNT BAR.....	114
FOOT PEGS.....	114
FORK AIR BLEEDER.....	88
FORK BUSHINGS ENGI®.....	120
FORK GUARDS.....	78
FORK OIL SEALS.....	88/120
FORK SEAL REPAIR KIT.....	88/120
FORKS.....	88/120
FORK TOOL.....	120
FRAMES.....	91
FUEL CAPS.....	93
FUEL HOSES.....	93
FUEL TANKS.....	93
FUEL PETCOCK.....	93
FUEL VENT CAP.....	93

G

GASKET SETS.....	130/132/133
GEARBOX FORK (REINFORCED).....	130
GEARBOX SHAFT.....	130
GEARBOX SHAFT (COMPLETE MAIN).....	130
GEARBOX SHAFT (COMPLETE SECONDARY).....	130
GP PARTS.....	60-64
GRAPHIC KITS.....	70-74
GRAPHICS FOR FRAME.....	70
GRIPS.....	87
GRIP DONUTS.....	87

H

HANDGUARDS.....	84
HANDLEBAR PADS.....	84
HANDLEBARS.....	85
HATS.....	68/69
HEAD LIGHTS.....	82
HEIGHT ADJUSTMENT KIT.....	104
HIGH TENSION IGNITION COIL.....	140
HOLESHOT DEVICE.....	120
HOODIE.....	68
HOOR METER.....	141
HUB SPACERS.....	110
HUBS.....	110

I

IDLE SCREW + SPRING.....	133
--------------------------	-----

IGNITION COVER	128
IGNITION SWITCH.....	140
INLET PIPE	134
INLET VALVE.....	130
INTAKE GASKET.....	134
INTAKE MANIFOLD	134

K

KICKSTAND (ADJUSTABLE).....	91
KICKSTAND SPRING	91
KICKSTARTER LEVER OIL SEAL	132
KICKSTARTER LEVERS	115
KICKSTARTER SPROCKET	132
KILL SWITCH.....	140

L

LIGHT.....	82
LEVER PROTECTION	84
LAUNCH CONTROL.....	118

M

MAGNETIC DRAIN PLUG	139
MAGNETO	140
MAIN JET	133
MOTORCYCLE COVER	66
MUD FLAP	104
MUDGUARDS.....	76/78/79/81
MUFFLER	136/137
MUFFLER CLAMPS	136/137
MUFFLER SPARK ARRESTOR.....	136

N

NEEDLE VALVE + SPRING	133
NUMBER PLATES.....	76/80
NUMBERS (CUSTOM).....	75
NUT FOR STEERING STEM.....	90

O

OIL COOLER	139
OIL DIPSTICK	139
OIL DRAIN PLUG	139
OIL FILTER	139
OIL LEVEL SIGHT GLASS.....	139
OIL SEAL	109
OIL SEAL ASSEMBLY TOOLS.....	118
OIL SEAL FOR COUNTERSHAFT SPROCKET	132
OIL STEEL LINE RETAINER	82
OVAL MUFFLER CLAMP	136

P

PISTON KITS	128/142
PISTON RING SETS	128
PIT TENT (3X3M).....	66
PLASTIC KITS.....	70-81
POLO	68
PUSH ROD.....	132

R

REAR BRAKE LEVER TIPS.....	98
REAR SPOOL.....	102
REGULATOR.....	140
REMOTE SWITCH.....	141
RIM LOCKS.....	109
RIMS.....	108-109
RUBBER MANIFOLD SET	134
RUBBER MAT.....	67

S

SEAL FOR FUEL TANK CAP.....	93
SEAL FOR STEERING STEM.....	90
SEATS	92
SHAFT	130
SHIFT LEVERS.....	115
SHOCK ABSORBERS	104/121
SHOCK ABSORBERS REPAIR KIT.....	121
SHOCK ABSORBERS SPACER KIT	121
SHOCK ABSORBERS SPRING	104
SIDE PLATES.....	70/79
SKID PLATE	115
SLOW JET.....	133
SPACERS	104/110
SPACERS FOR BAR MOUNT	89
SPARK ARRESTOR.....	136
SPARK PLUG REMOVAL TOOL	118
SPARK PLUGS	141
SPOKE SKINS.....	109
SPOKE TOOL.....	118
SPOKE WRENCH	118
SPOKES	109
SPROCKETS.....	116/117
SPROCKET GUARD	117
SPROCKET LOCKING TAB	117
STABILIZED WHEEL KIT	18
STAND SCREW & NUT	91
STANDARD LEVERS	87
STARTER CHAIN	128
STARTER RELAY	140
STICKER SHEET (YCF)	75
SUBFRAMES	91
SUPERMOTARD CATCH TANK KIT	114

SUPERMOTARD RACING PARTS.....	122-123
SUPERMOTARD TEFLON PROTECTION SET	114
SUPPORTING PLATE FOR HOUR METER	141
SWING ARMS	102
SWING ARM SLIDER	103
SWITCH REMOTE CUT OFF (50CC).....	141

T

TAIL LIGHT.....	82
TANK BOLT.....	133
TANK COVER.....	93
TANK SHROUDS.....	76/79
TAPER ROLLER BEARINGS	90
THREADLOCK.....	118
THROTTLE ADJUSTING SCREW.....	86
THROTTLE ASSEMBLY.....	87
THROTTLE CABLES	87
THROTTLE HANDLE.....	86
TIMING SPROCKET.....	128/142
TIRES.....	112/113
TIRE LEVER.....	118
TIRE VALVE CAPS	112
TIRE VALVE INNER	105
TIRE WARMERS.....	113
TOOLS	118/120
TRACK TAPE	66
TRAINING WHEEL KIT	18
TRANSPORT BAG.....	69
TRIPLE CLAMPS.....	88/89
T-SHIRTS	68
TUBES	18/112

U

UMBRELLA	68
----------------	----

V

VALVE ADJUSTMENT TOOL.....	118
VALVE CAP.....	112
VALVE STEM SEAL.....	130

W

WASHER FOR STEERING STEM NUT.....	90
WHEEL ASSEMBLY (COMPLETE)	18/105-108
WIRING HARNESS	140

Y

YCF PLASTIC HANDLES ON SIDE PLATES.....	77/80
-----------------------------------------	-------

Mini **YCF** 12

YCF MINI 12

400-470mm/ 16-18,5 in.

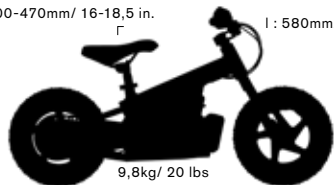

l : 580mm/ w: 23 in.

9,8kg/ 20 lbs

P.11

681mm/ w: 26,8 in.

981mm/ w: 38,6 in.

Mini **YCF** 16

YCF MINI 16

470-540mm/ 18,5-21 in.

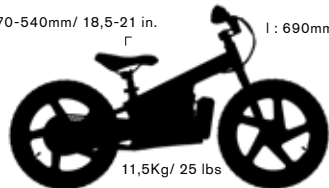

l : 690mm/ w: 27 in.

11,5Kg/ 25 lbs

P.13

771mm/ w: 30,3 in.

1177mm/ w: 46,3 in.



50AE
W50

STANDARD 550mm/ 21 in.
LOW 530mm/ 20 in.

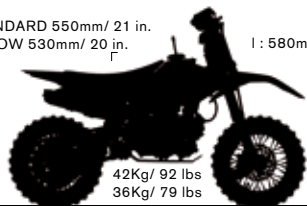

l : 580mm/ w: 23 in.

42Kg/ 92 lbs
36Kg/ 79 lbs

P.15
P.17

870mm/ w: 34 in.

1280mm/ w: 50 in.



W88

720mm/ 28 in.

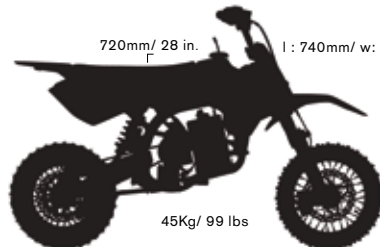

l : 740mm/ w: 29 in.

45Kg/ 99 lbs

P.27

1145mm/ 45 in.

1460mm/ 57 in.



LITE 88S

710mm/ 28 in.

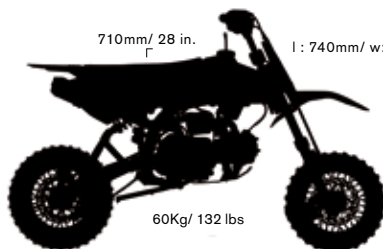

l : 740mm/ w: 29 in.

60Kg/ 132 lbs

P.21

1083mm/ 42 in.

1500mm/ 59 in.

LITE 125

750mm/ 30 in.

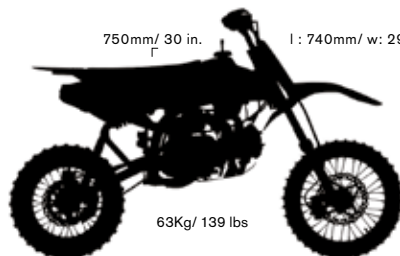

l : 740mm/ w: 29 in.

63Kg/ 139 lbs

P.23

1110mm/ 44 in.

1590mm/ 62 in.



TM

CHOOSE
YOUR
WEAPON

START

START 88SE

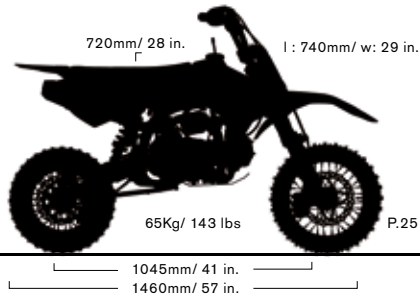

START 125
START 125SE

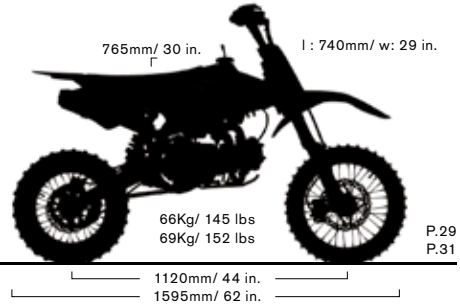

PILOT

PILOT 125

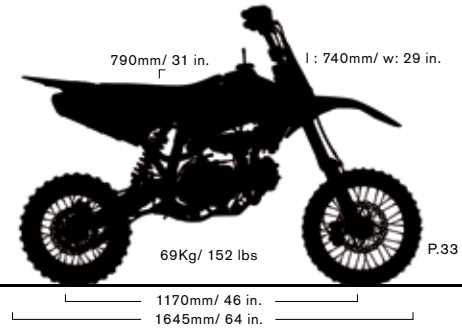

PILOT 150E

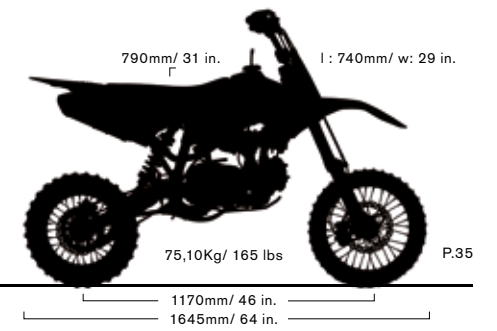

FACTORY

FACTORY 150 SP2

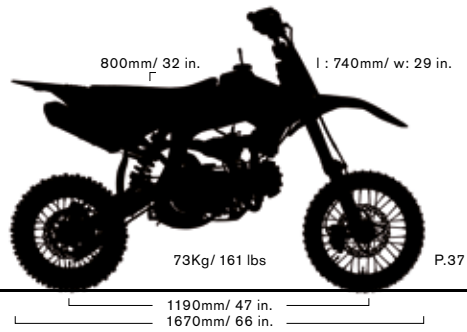

FACTORY 190 SP3 DAYTONA®

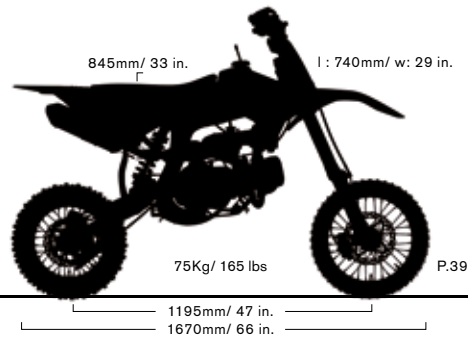

SM

SM 125

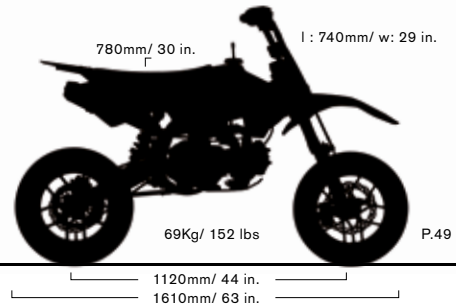

SM 155
SM 190 DAYTONA®

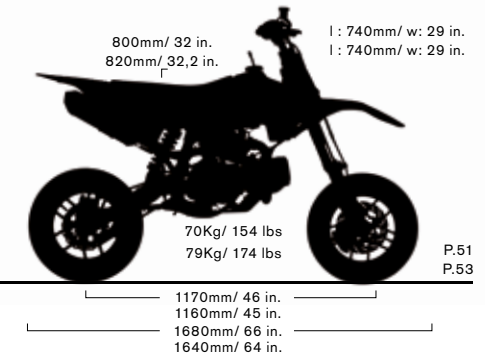

city

BIGY 125
BIGY 150

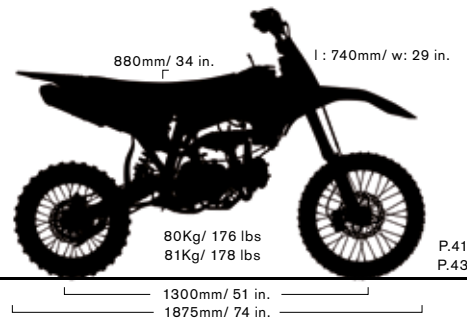

BIGY 150E FACTORY XL
BIGY 190 FACTORY DAYTONA® XL

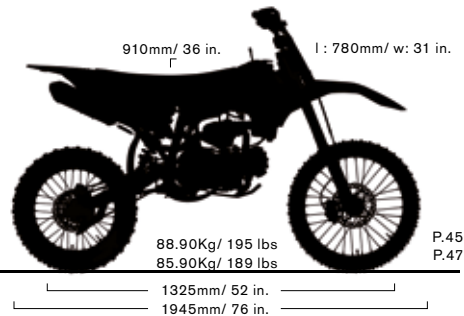

GP

GP 124
GP 157
GP 187 DAYTONA®

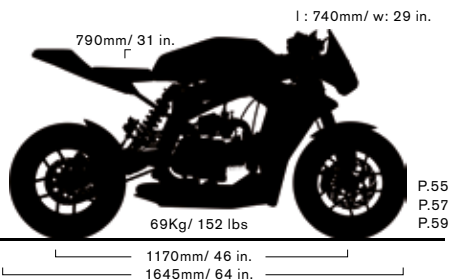



€469

SPÉCIFICATIONS

MOTEUR DE 170W
BATTERIE LITHIUM 24V
TEMPS DE CHARGE DE 2,5-3 HEURES
AUTONOMIE MOYENNE DE LA BATTERIE DE 60 MINUTES
VARIABLE SELON L'UTILISATION

SPECIFICATIONS

ENGINE 170W
BATTERY LITHIUM 24V
CHARGE TIME 2,5-3 HOURS
AN AVERAGE BATTERY LIFE OF 60 MINUTES
VARYING WITH USAGE

**2025 YCF MINI 12
POCKET-ROCKET**

POINTS FORTS & NOUVEAUTÉS 2025

TROIS VITESSES POSSIBLES
SYSTÈME DE ROUE LIBRE ARRIÈRE
RETRAIT FACILE DE LA BATTERIE
POUR LES ENFANTS DE 3 À 5 ANS
CADRE EN ALUMINIUM
TAILLE DE LA ROUE 12'

HIGHLIGHTS & 2025 NEW FEATURES

3 SPEED POSITIONS
FREEWHEEL
EASY BATTERY REMOVAL
FOR CHILDREN FROM 3 TO 5 YEARS OLD
ALUMINUM FRAME
WHEEL SIZE 12'

Mini **YCF** 12



400-470mm / 16-18,5 in.



 9,8Kg / 20 lbs

l : 580mm / w : 23 in.

681mm / 26,8 in.

981mm / 38,6 in.



€569

SPÉCIFICATIONS

MOTEUR DE 250W
BATTERIE LITHIUM 24V
TEMPS DE CHARGE DE 5-6 HEURES
AUTONOMIE MOYENNE DE LA BATTERIE DE 60 MINUTES,
VARIABLE SELON L'UTILISATION

SPECIFICATIONS

ENGINE 250W
BATTERY LITHIUM 24V
CHARGE TIME 5-6 HOURS
AN AVERAGE BATTERY LIFE OF 60 MINUTES,
VARYING WITH USAGE

**2025 YCF MINI 16
 POCKET-ROCKET**

POINTS FORTS & NOUVEAUTÉS 2025

TROIS VITESSES POSSIBLES
SYSTÈME DE ROUE LIBRE ARRIÈRE
RETRAIT FACILE DE LA BATTERIE
POUR LES ENFANTS DE 5 À 7 ANS
CADRE EN ALUMINIUM
TAILLE DE LA ROUE 16"

HIGHLIGHTS & 2025 NEW FEATURES

3 SPEED POSITIONS
FREEWHEEL
EASY BATTERY REMOVAL
FOR CHILDREN FROM 5 TO 7 YEARS OLD
ALUMINUM FRAME
WHEEL SIZE 16"

Mini **YEF** 16



470-540mm / 18,5-21 in.

 11,5Kg / 25 lbs

L : 690mm / W : 27 in.

771mm / 30,3 in.

1177mm / 46,3 in.



DISPONIBLE/ AVAILABLE PAGE 18

€1399

SPÉCIFICATIONS

**MOTEUR: MONO CYLINDRE REFROIDISSEMENT
À AIR/ AUTOMATIQUE**
FOURCHE INVERSÉE 530mm
SUSPENSION ARRIÈRE 200mm
PNEUS AV. & AR. : 2.50/10 - 2.50/10

SPECIFICATIONS

ENGINE TYPE: SINGLE CYLINDER AIR
COOLING/ AUTOMATIC GEAR BOX
530mm UPSD FORK
200mm REAR SUSPENSION
FRONT & REAR TIRES: 2.50/10 - 2.50/10

2025 50AE FUN FANATIC

POINTS FORTS & NOUVEAUTÉS 2025

MOTEUR 4T 50CC
STARTER AU GUIDON
DÉMARREUR ÉLECTRIQUE
PRISE RAPIDE DE CHARGEUR DE BATTERIE
POIGNÉE GAZ RÉGLABLE
42 KGS SEULEMENT
FREIN AVANT ET FREIN ARRIÈRE HYDRAULIQUE
TÉ FOURCHE SUPÉRIEUR 4 POSITIONS
RÉGLAGE DE LA HAUTEUR POSSIBLE
NOUVEAU RÉSERVOIR

HIGHLIGHTS & 2025 NEW FEATURES

50CC 4 STROKE ENGINE
START BUTTON
ELECTRIC START
FAST BATTERY CHARGING
ADJUSTABLE THROTTLE
ONLY 92 LBS IN WEIGHT
HYDRAULIC BRAKE SYSTEM
UPPER CLAMP 4 POSITIONS BAR MOUNT
ADJUSTABLE HEIGHT
NEW FUEL TANK



STANDARD 550mm/ 21 in.
LOW 530mm/ 20 in.

 42Kg/ 92 lbs

L : 580mm/ W: 23 in.

870mm/ 34 in.

1270mm/ 50 in.



DISPONIBLE/ AVAILABLE PAGE 18

€1999

SPÉCIFICATIONS

MOTEUR: ÉLECTRIQUE 48v
BATTERIE LITHIUM 10aH
FOURCHE INVERSÉE 530mm
SUSPENSION ARRIÈRE 200mm
PNEU AV. & ARR.: 2.50/10 - 2.50/ 10

SPECIFICATIONS

48v ELECTRIC
 10 Ah LITHIUM BATTERY
 530mm UPSD FORK
 200mm REAR SUSPENSION
 FRONT & REAR TIRES: 2.50/10 - 2.50/ 10

2025 W50
SILENCE BUILT TO PERFECTION

POINTS FORTS & NOUVEAUTÉS 2025

MOTEUR ÉLECTRIQUE NÉODYMIUM MAGNET DC 1200W/ 48V
BATTERIE LITHIUM/ TEMPS DE CHARGE 4H
AUTONOMIE 1H30
CHARGEUR LI-ION 110V/ 220V
RÉGLAGE PARENTAL (POTENTIOMÈTRE)
POIGNÉE GAZ INDICATEUR CHARGE BATTERIE
36KG SEULEMENT
RÉGLAGE DU TEMPS DE RÉPONSE À L'ACCÉLÉRATION
FREIN AVANT ET FREIN ARRIÈRE HYDRAULIQUE
VITESSE RÉGLABLE
FREINS À DISQUE AVANT ARRIÈRE AU GUIDON

HIGHLIGHTS & 2025 NEW FEATURES

1200W/ 48V NEODYMIUM MAGNET DC ENGINE
 LITHIUM BATTERY/ CHARGING TIME 4 HOURS
 BATTERY LIFE 1H30
 LI-ION BATTERY CHARGER 110V/ 220V
 SPEED DIAL (POTENTIOMETER)
 THROTTLE WITH BATTERY CHARGE INDICATOR
 ONLY 79 LBS IN WEIGHT
 ACCELERATION RESPONSE TIME ADJUSTMENT
 HYDRAULIC BRAKE SYSTEM
 ADJUSTABLE SPEED POSITION
 HANDLEBAR FRONT REAR BRAKE DISC



STANDARD 550mm/ 21 in.
LOW 530mm/ 20 in.

 36Kg/ 79 lbs

L : 580mm/ W: 23 in.

870mm/ 34 in.

1270mm/ 50 in.



FOR 50 ONLY

KIT STABILISATEUR POUR YCF 50
STABILIZER WHEEL KIT FOR YCF 50

N° YC50-2105

ROUE POUR KIT STABILISATEUR
WHEEL FOR STABILIZER WHEEL KIT

01 N° YC50-2101

CHAMBRE À AIR POUR KIT STABILISATEUR
TUBE FOR STABILIZER WHEEL KIT

03 N° YC50-2106

GARDE BOUE POUR KIT STABILISATEUR
MUDGUARD FOR STABILIZER WHEEL KIT

02 N° YC50-2103 (GAUCHE/ LEFT)
02 N° YC50-2104 (DROIT/ RIGHT)



PAGE 93

PAGE 87

PAGE 87

PAGE 112

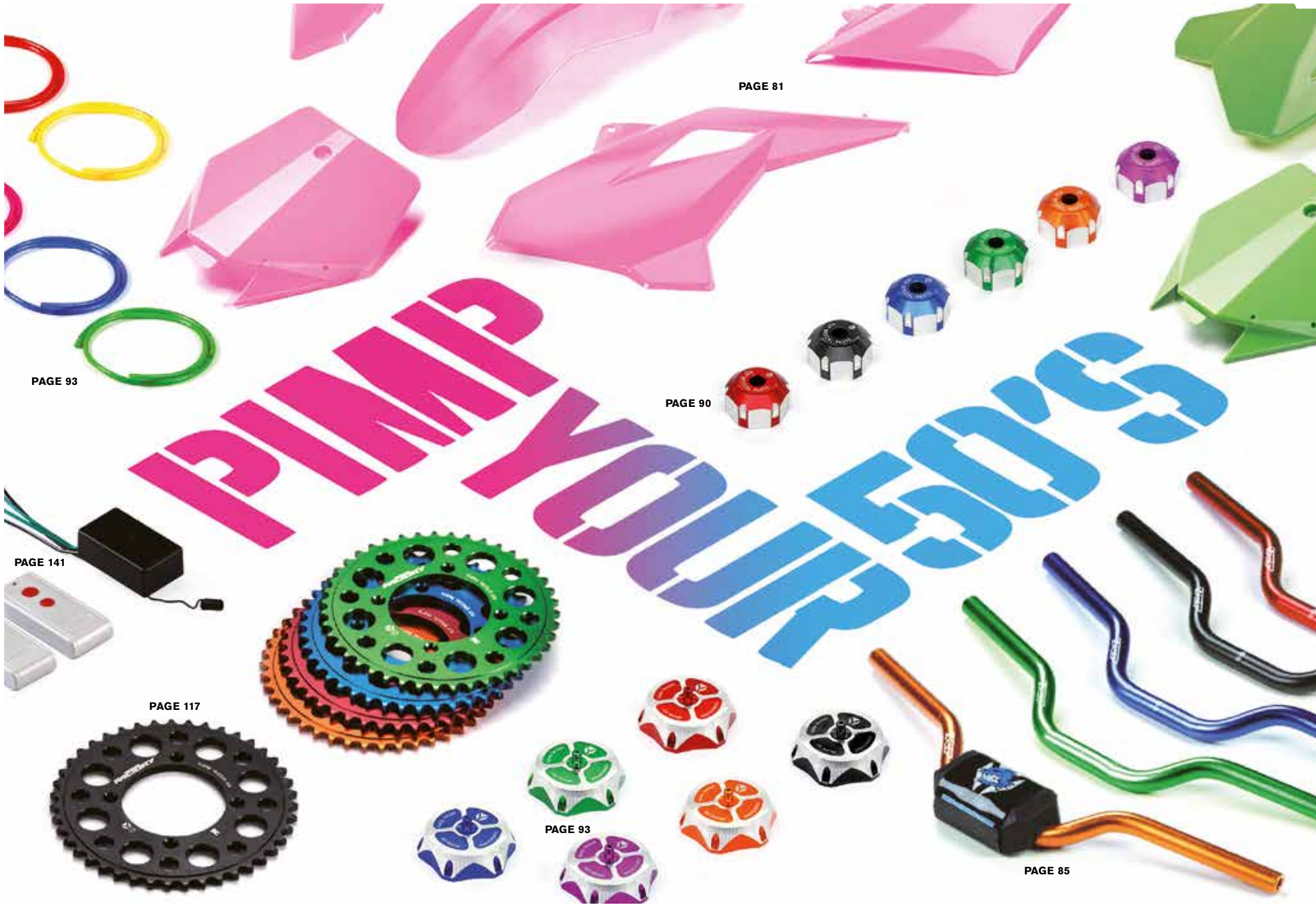

PAGE 81

PAGE 93

PAGE 90

PAGE 141

PAGE 117

PAGE 93

PAGE 85



€1299

SPÉCIFICATIONS

MOTEUR: MONO CYLINDRE 4 TEMPS 88cc
4 VITESSES EMBRAYAGE SEMI AUTOMATIQUE
FOURCHE 600mm
SUSPENSION ARRIÈRE 265mm
PNEUS AV. & AR. : 250/10 - 300/10

SPECIFICATIONS

ENGINE TYPE: SINGLE CYLINDER 4 STROKE 88cc
4 GEARS (N1234) WITH AUTOMATIC CLUTCH
600mm FORK
265mm REAR SUSPENSION
FRONT & REAR TIRES: 250/10 - 300/10

2025 LITE 88S LIGHT IS RIGHT!

POINTS FORTS & NOUVEAUTÉS 2025

POIGNÉE DE GAZ RÉGLABLE
SEMI-AUTOMATIQUE
SELLE BASSE COMPATIBLE PAGE 92
FILTRE À AIR YCF
POIGNÉE CAOUTCHOUC YCF
KIT RABASSE AMORTISSEUR PAGE 104
TÉ FOURCHE SUPÉRIEUR 3 POSITIONS
NOUVELLE SELLE

HIGHLIGHTS & 2025 NEW FEATURES

ADJUSTABLE THROTTLE
SEMI-AUTOMATIC
COMPATIBLE LOW SEAT PAGE 92
YCF AIR FILTER
YCF GRIPS
HEIGHT ADJUSTMENT KIT PAGE 104
UPPER CLAMP 3 POSITIONS BAR MOUNT
NEW SEAT

LTE 885



710mm/ 28 in.

 60Kg/ 132 lbs

L : 740mm/ W: 29 in.

1083mm/ 42 in.

1500mm/ 59 in.



€1399

SPÉCIFICATIONS

MOTEUR: MONO CYLINDRE 4 TEMPS 125cc
4 VITESSES EMBRAYAGE
FOURCHE 650mm
SUSPENSION ARRIÈRE 270mm
PNEUS AV. & AR. : 60/100/14 - 80/100/12

SPECIFICATIONS

ENGINE TYPE: SINGLE CYLINDER 4 STROKE 125cc
4 GEARS (N1234)
650mm FORK
270mm REAR SUSPENSION
FRONT & REAR TIRES: 60/100/14 - 80/100/12

2025 LITE 125 LIGHT? YOU BET!

POINTS FORTS & NOUVEAUTÉS 2025

POIGNÉE DE GAZ RÉGLABLE
EMBRAYAGE MANUEL
SELLE BASSE COMPATIBLE PAGE 92
FILTRE À AIR YCF
POIGNÉE CAOUTCHOUC YCF
KIT RABASSE AMORTISSEUR PAGE 104
TÉ FOURCHE SUPÉRIEUR 3 POSITIONS
NOUVELLE SELLE

HIGHLIGHTS & 2025 NEW FEATURES

ADJUSTABLE THROTTLE
MANUAL CLUTCH
COMPATIBLE LOW SEAT PAGE 92
YCF AIR FILTER
YCF GRIPS
HEIGHT ADJUSTMENT KIT PAGE 104
UPPER CLAMP 3 POSITIONS BAR MOUNT
NEW SEAT

LTE 125



750mm/ 30 in.

 63Kg/ 139 lbs

L : 740mm/ W: 29 in.

1110mm/ 44 in.

1590mm/ 62 in.



€1599

SPÉCIFICATIONS

MOTEUR: MONO CYLINDRE 4 TEMPS 88cc
4 VITESSES EMBRAYAGE SEMI AUTOMATIQUE
FOURCHE INVERSÉE 600mm
SUSPENSION ARRIÈRE RÉGLABLE 265mm
PNEUS AV. & AR. : 60/100/12 - 300/10

SPECIFICATIONS

ENGINE TYPE: SINGLE CYLINDER 4 STROKE 88cc
4 GEARS (N1234) WITH AUTOMATIC CLUTCH
600mm UPSD FORK
265mm ADJUSTABLE REAR SUSPENSION
FRONT & REAR TIRES: 60/100/12 - 300/10

2025 START 88SE MAGIC BUTTON

POINTS FORTS & NOUVEAUTÉS 2025

DÉMARREUR ÉLECTRIQUE
SEMI-AUTOMATIQUE
POIGNÉE DE GAZ RÉGLABLE
BOUTON DE DÉMARREUR ÉTANCHE
SELLE BASSE COMPATIBLE PAGE 92
FILTRE À AIR YCF
POIGNÉE CAOUTCHOUC YCF
TÉ FOURCHE SUPÉRIEUR 3 POSITIONS
NOUVELLE SELLE
RÉGLAGE DE LA HAUTEUR POSSIBLE

HIGHLIGHTS & 2025 NEW FEATURES

ELECTRIC STARTER
SEMI-AUTOMATIC
ADJUSTABLE THROTTLE
WATERPROOF START BUTTON
COMPATIBLE LOW SEAT PAGE 92
YCF AIR FILTER
YCF GRIPS
UPPER CLAMP 3 POSITIONS BAR MOUNT
NEW SEAT
ADJUSTABLE HEIGHT

START 88⁵



720mm/ 28 in.

 65Kg/ 143 lbs

L : 740mm/ W: 29 in.

1045mm/ 41 in.

1460mm/ 57 in.



€2799

SPÉCIFICATIONS

MOTEUR: ÉLECTRIQUE 60V
BATTERIE LITHIUM 20Ah
FOURCHE INVERSÉE 600mm
SUSPENSION ARRIÈRE RÉGLABLE 265mm
PNEUS AV. & AR.: 60/100/12 - 300/10

SPECIFICATIONS

ENGINE TYPE: 60V ELECTRIC
 20Ah LITHIUM BATTERY
 600mm UPSD FORK
 265mm ADJUSTABLE REAR SUSPENSION
 FRONT & REAR TIRES: 60/100/12 - 300/10

2025 W88
THE NEW ERA OF ELECTRIC

POINTS FORTS & NOUVEAUTÉS 2025

MOTEUR BRUSHLESS 60V
BATTERIE LITHIUM/ TEMPS DE CHARGE 4H
AUTONOMIE ENTRE 1H00 ET 1H30
CHARGEUR RAPIDE LI-ION 110V/ 240V
45 KG SEULEMENT
RÉGLAGE 3 VITESSES
SELLE BASSE COMPATIBLE PAGE 92
KIT RABASSE ADAPTABLE PAGE 104
RÉGLAGE DE LA HAUTEUR POSSIBLE
CHAÎNE-COURONNE-PSB EN 420
NOUVELLE SELLE

HIGHLIGHTS & 2025 NEW FEATURES

60V BRUSHLESS ENGINE (BDLC)
 LITHIUM BATTERY/ CHARGING TIME 4 HOURS
 BATTERY LIFE 1:00 BETWEEN 1H AND 1H30
 LI-ION BATTERY FAST CHARGER 110V/ 240V
 ONLY 99 LBS IN WEIGHT
 ADJUSTABLE 3 SPEEDS
 COMPATIBLE LOW SEAT PAGE 92
 HEIGHT ADJUSTMENT KIT PAGE 104
 ADJUSTABLE HEIGHT
 SPROCKET-CHAIN-PSB EN 420
 NEW SEAT



720mm/ 28 in.

 45Kg/ 99 lbs

L : 740mm/ W: 29 in.

1145mm/ 45 in.

1460mm/ 57 in.



€1599

SPÉCIFICATIONS

MOTEUR: MONO CYLINDRE 4 TEMPS 125cc
4 VITESSES EMBRAYAGE
FOURCHE INVERSÉE 660mm
SUSPENSION ARRIÈRE RÉGLABLE 270mm
PNEUS AV. & AR.: 60/100/14 - 80/100/12

SPECIFICATIONS

ENGINE TYPE: SINGLE CYLINDER 4 STROKE 125cc
4 GEARS (N1234)
660mm UPSD FORK
270mm ADJUSTABLE REAR SUSPENSION
FRONT & REAR TIRES: 60/100/14 - 80/100/12

2025 START 125 FAST & EASY

POINTS FORTS & NOUVEAUTÉS 2025

POIGNÉE DE GAZ RÉGLABLE
JOINT ÉTANCHE DE COLONNE DE DIRECTION
SELLE BASSE COMPATIBLE PAGE 92
KIT RABASSE ADAPTABLE PAGE 104
FILTRE À AIR YCF
POIGNÉE CAOUTCHOUC YCF
TÉ FOURCHE SUPÉRIEUR 3 POSITIONS
NOUVELLE SELLE

HIGHLIGHTS & 2025 NEW FEATURES

ADJUSTABLE THROTTLE
SEALING WASHER FOR STEERING STEM
COMPATIBLE LOW SEAT PAGE 92
HEIGHT ADJUSTMENT KIT PAGE 104
YCF AIR FILTER
YCF GRIPS
UPPER CLAMP 3 POSITIONS BAR MOUNT
NEW SEAT

START 125



765mm/ 30 in.

 66Kg/ 145 lbs

L : 740mm/ W: 29 in.

1120mm/ 44 in.

1595mm/ 62 in.



€1699

SPÉCIFICATIONS

MOTEUR: MONO CYLINDRE 4 TEMPS 125cc
4 VITESSES EMBRAYAGE SEMI AUTOMATIQUE
FOURCHE INVERSÉE 660mm
SUSPENSION ARRIÈRE RÉGLABLE 270mm
PNEUS AV. & AR.: 60/100/14 - 80/100/12

SPECIFICATIONS

ENGINE TYPE: SINGLE CYLINDER 4 STROKE 125cc
4 GEARS (N1234) WITH AUTOMATIC CLUTCH
660mm UPSD FORK
270mm ADJUSTABLE REAR SUSPENSION
FRONT & REAR TIRES: 60/100/14 - 80/100/12

2025 START 125SE THE ULTIMATE BATTLE MACHINE

POINTS FORTS & NOUVEAUTÉS 2025

DÉMARREUR ÉLECTRIQUE
SEMI-AUTOMATIQUE
POIGNÉE DE GAZ RÉGLABLE
SELLE BASSE COMPATIBLE PAGE 92
FILTRE À AIR YCF
POIGNÉE CAOUTCHOUC YCF
TÉ FOURCHE SUPÉRIEUR 3 POSITIONS
NOUVELLE SELLE

HIGHLIGHTS & 2025 NEW FEATURES

ELECTRIC START
SEMI-AUTOMATIC
ADJUSTABLE THROTTLE
COMPATIBLE LOW SEAT PAGE 92
YCF AIR FILTER
YCF GRIPS
UPPER CLAMP 3 POSITIONS BAR MOUNT
NEW SEAT

START 125^{RS}



765mm/ 30 in.

 69Kg/ 152 lbs

L : 740mm/ W: 29 in.

1120mm/ 44 in.

1595mm/ 62 in.



€1899

SPÉCIFICATIONS

MOTEUR: MONO CYLINDRE
4 TEMPS 125cc/ 4 VITESSES
FOURCHE INVERSÉE 735mm
SUSPENSION ARRIÈRE RÉGLABLE 330mm
PNEUS AV. & AR. : 60/100/14 - 80/100/12

SPECIFICATIONS

ENGINE TYPE: SINGLE CYLINDER
4 STROKE 125cc/ 4 GEARS (N1234)
FORK: 735mm UPSD FORK
REAR SUSPENSION: 330mm ADJUSTABLE
FRONT & REAR TIRES: 60/100/14 - 80/100/12

2025 PILOT 125 WORLD CLASS SIZE

POINTS FORTS & NOUVEAUTÉS 2025

POIGNÉE CAOUTCHOUC YCF
TÉ FOURCHE SUPÉRIEUR 3 POSITIONS
MOTEUR 125 ZONGSHEN FIDDY RACER
CARBURATEUR NIBBI PE24SP
NOUVELLE BOÎTE AIR
NOUVEAU SILENCIEUX
NOUVEAU PATIN CHAÎNE
NOUVEAU GUIDE CHAÎNE

HIGHLIGHTS & 2025 NEW FEATURES

YCF GRIPS
UPPER CLAMP 3 POSITIONS BAR MOUNT
ZONGSHEN 125 FIDDY RACER ENGINE
NIBBI PE24SP CARBURETOR
NEW AIRBOX
NEW MUFFLER
NEW CHAIN SLIDER
NEW CHAIN GUIDE

PILOT 125



790mm/ 31 in.

 69Kg/ 152 lbs

L : 740mm/ W: 29 in.

1170mm/ 46 in.

1645mm/ 64 in.



€1999

SPÉCIFICATIONS

MOTEUR: MONOCYLINDRE 4 TEMPS
150cc/ 4 VITESSES (N1234)
FOURCHE INVERSÉE 735mm
SUSPENSION ARRIÈRE RÉGLABLE 330mm
PNEUS AV. & AR. : 60/100/14 - 80/100/12

SPECIFICATIONS

ENGINE TYPE: SINGLE CYLINDER 4 STROKE
150cc/ 4 GEARS (N1234)
735mm UPSD FORK
330mm ADJUSTABLE REAR SUSPENSION
FRONT & REAR TIRES: 60/100/14 - 80/100/12

2025 PILOT 150E THE ULTIMATE F150E

POINTS FORTS & NOUVEAUTÉS 2025

POIGNÉE CAOUTCHOUC YCF
TÉ FOURCHE SUPÉRIEUR 3 POSITIONS
DÉMARREUR ELECTRIQUE
CARBURATEUR NIBBI PE24SP
NOUVELLE BOÎTE AIR
NOUVEAU SILENCIEUX
NOUVEAU PATIN CHAÎNE
NOUVEAU GUIDE CHAÎNE

HIGHLIGHTS & 2025 NEW FEATURES

YCF GRIPS
UPPER CLAMP 3 POSITIONS BAR MOUNT
ELECTRIC START
NIBBI PE24SP CARBURETOR
NEW AIRBOX
NEW MUFFLER
NEW CHAIN SLIDER
NEW CHAIN GUIDE

PILOT 150



790mm/ 31 in.

 75,10Kg/ 165 lbs

L : 740mm/ W: 29 in.

1170mm/ 46 in.

1645mm/ 64 in.



€2699

SPÉCIFICATIONS

MOTEUR: MONOCYLINDRE 4 TEMPS
150cc TYPE KLX/ 4 VITESSES
FOURCHE INVERSÉE RÉGLABLE 735mm
SUSPENSION ARRIÈRE RÉGLABLE 330mm
PNEUS AV. & AR.: 60/100/14 - 80/100/12 ARRO®

SPECIFICATIONS

ENGINE TYPE: SINGLE CYLINDER 4 STROKE
 150cc KLX TYPE/ 4 GEARS (N1234)
 735mm ADJUSTABLE UPSD FORK
 330mm ADJUSTABLE REAR SUSPENSION
 FRONT & REAR TIRES: 60/100/14 - 80/100/12 ARRO®

2025 FACTORY 150 SP2 RACE READY

POINTS FORTS & NOUVEAUTÉS 2025

MOYEURS AVANT/ ARRIÈRE ALUMINIUM CNC
COURONNE 5 TROUS
PNEUS ARRO® AVANT/ ARRIÈRE
CERCEAU DE ROUE ALUMINIUM 7116 NOIR
BAVETTE AMORTISSEUR
TÉ FOURCHE SUPÉRIEUR 3 POSITIONS
BRAS OSCILLANT ALUMINIUM 420mm
CARBURATEUR NIBBI PE24SP
NOUVELLE BOÎTE AIR
NOUVEAU SILENCIEUX
NOUVEAU PATIN CHAÎNE
NOUVEAU GUIDE CHAÎNE

HIGHLIGHTS & 2025 NEW FEATURES

ALUMINUM CNC FRONT/ REAR HUBS
 5 BOLT SPROCKET
 FRONT/ REAR ARRO® TIRES
 ALUMINIUM 7116 BLACK RIMS
 MUD FLAP
 UPPER CLAMP 3 POSITIONS BAR MOUNT
 420mm ALUMINIUM SWING ARM
 NIBBI PE24SP CARBURETOR
 NEW AIRBOX
 NEW MUFFLER
 NEW CHAIN SLIDER
 NEW CHAIN GUIDE

FACTORY 150 SP2



800mm / 32 in.

 73Kg / 161 lbs

L : 740mm / W: 29 in.

1190mm / 47 in.

1670mm / 66 in.



€3699

SPÉCIFICATIONS

MOTEUR: MONO CYLINDRE 4T, 4 SOUPAPES 190cc
DAYTONA® ANIMA® / 4 VITESSES
FOURCHE ENGI® INVERSÉE RÉGLABLE 800mm
SUSPENSION ARRIÈRE ENGI® RÉGLABLE 335mm
PNEUS AV. & AR. ARRO® : 60/100/14 - 80/100/12
CARBURATEUR NIBBI® 28

SPECIFICATIONS

ENGINE TYPE: DAYTONA® ANIMA® SINGLE CYLINDER 4V
 4 STROKE 190cc/ 4 GEARS (N1234)
 800mm ENGI® UPSD ADJUSTABLE FORK
 335mm ENGI® ADJUSTABLE REAR SUSPENSION
 FRONT & REAR ARRO® TIRES: 60/100/14 - 80/100/12
 NIBBI® 28 CARBURETOR

DAYTONA ENGI® ARRO™

2025 FACTORY 190 SP3 DAYTONA CATCH ME IF YOU CAN

POINTS FORTS & NOUVEAUTÉS 2025

BRAS OSCILLANT 460mm
TÉ 170mm
MOYEURS AVANT/ ARRIÈRE ALUMINIUM CNC
GUIDON YCF 28,6MM
REPOSE PIED INOX
PÉDALE DE FREIN ALUMINIUM
TÉ FOURCHE SUPÉRIEUR 3 POSITIONS
NOUVELLE BOÎTE AIR
NOUVEAU SILENCIEUX
NOUVEAU PATIN CHAÎNE
NOUVEAU GUIDE CHAÎNE

HIGHLIGHTS & 2025 NEW FEATURES

460mm SWINGARM
 170mm TRIPLE CLAMPS
 ALUMINIUM CNC FRONT/ REAR HUBS
 YCF FAT BAR 28,6mm HANDLEBAR
 INOX FOOT PEGS
 ALUMINIUM BRAKE PEDAL
 UPPER CLAMP 3 POSITIONS BAR MOUNT
 NEW AIRBOX
 NEW MUFFLER
 NEW CHAIN SLIDER
 NEW CHAIN GUIDE

FACTORY 190 SP3

DAYTONA



845mm / 33 in.

 75Kg / 165 lbs

L : 740mm / W: 29 in.

1195mm / 47 in.

1670mm / 66 in.



€2299

SPÉCIFICATIONS

MOTEUR: MONO CYLINDRE
4 TEMPS 125cc/ 4 VITESSES
FOURCHE INVERSÉE 785mm
SUSPENSION ARRIÈRE RÉGLABLE 355mm
PNEUS AV. & AR. : 70/100/17 - 90/100/14

SPECIFICATIONS

ENGINE TYPE: SINGLE CYLINDER
4 STROKE 125cc/ 4 GEARS (N1234)
FORK: 785mm UPSD FORK
REAR SUSPENSION: 355mm ADJUSTABLE
FRONT & REAR TIRES: 70/100/17 - 90/100/14

2025 BIGY 125 EASY TO PICK UP

POINTS FORTS & NOUVEAUTÉS 2025

ROUE AVANT 17"/ ARRIÈRE 14"
BAVETTE AMORTISSEUR
LEVIER DE FREIN PLIABLE
TÉ FOURCHE SUPÉRIEUR 3 POSITIONS
MOTEUR ZONGSHEN 125 FIDDY RACER
CARBURATEUR NIBBI® PE24
NOUVELLE BOÎTE AIR
NOUVEAU SILENCIEUX
NOUVEAU PATIN CHÂÎNE
NOUVEAU GUIDE CHÂÎNE
NOUVEAU RÉSERVOIR

HIGHLIGHTS & 2025 NEW FEATURES

FRONT 17"/ REAR 14" WHEEL
MUD FLAP
FOLDABLE FRONT BRAKE LEVER
UPPER CLAMP 3 POSITIONS BAR MOUNT
ZONGSHEN 125 FIDDY RACER ENGINE
NIBBI® PE24 CARBURETOR
NEW AIRBOX
NEW MUFFLER
NEW CHAIN SLIDER
NEW CHAIN GUIDE
NEW TANK

WGP 125



880mm/ 34 in.

 80Kg/ 176 lbs

L : 740mm/ W: 29 in.

1300mm/ 51 in.

1875mm/ 74 in.



€2499

SPÉCIFICATIONS

MOTEUR: MONO CYLINDRE
4 TEMPS 150cc/ 4 VITESSES
FOURCHE INVERSÉE 785mm
SUSPENSION ARRIÈRE RÉGLABLE 355mm
PNEUS AV. & AR. : 70/100/17 - 90/100/14

SPECIFICATIONS

ENGINE TYPE: SINGLE CYLINDER
4 STROKE 150cc/ 4 GEARS (N1234)
FORK: 785mm UPSD FORK
REAR SUSPENSION: 355mm ADJUSTABLE
FRONT & REAR TIRES: 70/100/17 - 90/100/14

2025 BIGY 150 BIGGER! FASTER! STRONGER!

POINTS FORTS & NOUVEAUTÉS 2025

ROUE AVANT 17" / ARRIÈRE 14"
BAVETTE AMORTISSEUR
LEVIER DE FREIN PLIABLE
TÉ FOURCHE SUPÉRIEUR 3 POSITIONS
CARBURATEUR NIBBI® PE24
NOUVELLE BOÎTE AIR
NOUVEAU SILENCIEUX
NOUVEAU PATIN CHÂÎNE
NOUVEAU GUIDE CHÂÎNE
NOUVEAU RÉSERVOIR

HIGHLIGHTS & 2025 NEW FEATURES

FRONT 17" / REAR 14" WHEEL
MUD FLAP
FOLDABLE FRONT BRAKE LEVER
UPPER CLAMP 3 POSITIONS BAR MOUNT
NIBBI® PE24 CARBURETOR
NEW AIRBOX
NEW MUFFLER
NEW CHAIN SLIDER
NEW CHAIN GUIDE
NEW TANK

bigX 150



880mm/ 34 in.

 81Kg/ 178 lbs

L : 740mm/ W: 29 in.

1300mm/ 51 in.

1875mm/ 74 in.



€2999

SPÉCIFICATIONS

MOTEUR: MONOCYLINDRE 4 TEMPS
150cc YX/ 4 VITESSES
DÉMARREUR ÉLECTRIQUE
FOURCHE INVERSÉE RÉGLABLE 800mm
SUSPENSION ARRIÈRE RÉGLABLE 355mm
PNEUS AV. & AR.: 70/100/19 - 90/100/16
CARBURATEUR NIBBI® 28

SPECIFICATIONS

ENGINE TYPE: SINGLE CYLINDER 4 STROKE
 150cc YX/ 4 GEARS
 ELECTRIC START
 800mm ADJUSTABLE UPSD FORK
 355mm ADJUSTABLE REAR SUSPENSION
 FRONT & REAR TIRES: 70/100/19 - 90/100/16
 NIBBI® 28 CARBURETOR

2025 BIGY 150E FACTORY XL
ELECTRIC START

POINTS FORTS & NOUVEAUTÉS 2025

ROUE AVANT 19"/ ARRIÈRE 16"
JANTES ALUMINIUM 7116
MOYEURS AVANT/ ARRIÈRE ALUMINIUM CNC
BAVETTE AMORTISSEUR
REPOSE PIED INOX
PÉDALE DE FREIN ALUMINIUM
TÉ FOURCHE SUPÉRIEUR 3 POSITIONS
NOUVELLE BOÎTE AIR
NOUVEAU SILENCIEUX
NOUVEAU PATIN CHAÎNE
NOUVEAU GUIDE CHAÎNE
NOUVEAU RÉSERVOIR

HIGHLIGHTS & 2025 NEW FEATURES

FRONT 19"/ REAR 16" WHEEL
 ALUMINIUM 7116 RIMS
 ALUMINIUM FRONT/ REAR CNC HUBS
 MUD FLAP
 INOX FOOT PEGS
 ALUMINIUM BRAKE PEDAL
 UPPER CLAMP 3 POSITIONS BAR MOUNT
 NEW AIRBOX
 NEW MUFFLER
 NEW CHAIN SLIDER
 NEW CHAIN GUIDE
 NEW TANK

bigX XL 150



910mm / 36 in.

 85,90Kg / 195 lbs

L : 780mm / W: 31 in.

1325mm / 52 in.

1945mm / 76 in.



€3799

SPÉCIFICATIONS

MOTEUR: MONO CYLINDRE 4T, 4 SOUPAPES 190cc
DAYTONA® ANIMA® / 4 VITESSES
MOTEUR 4 VITESSES
FOURCHE ENGI® INVERSÉE RÉGLABLE 800mm
SUSPENSION ARRIÈRE ENGI® RÉGLABLE 355mm
PNEUS AV. & AR.: 70/100/19 - 90/100/16
ROUE AVANT 19" / ARRIÈRE 16"
CARBURATEUR NIBBI® 28

SPECIFICATIONS

ENGINE TYPE: DAYTONA® ANIMA® SINGLE CYLINDER 4V
 4 STROKE 190cc/ 4 GEARS (N1234)
 4 SPEED ENGINE
 800mm ENGI® UPSD ADJUSTABLE FORK
 355mm ENGI® ADJUSTABLE REAR SUSPENSION
 FRONT & REAR TIRES: 70/100/19 - 90/100/16
 FRONT WHEEL 19" & REAR 16"
 NIBBI® 28 CARBURETOR

DAYTONA ENGI® ARRO™

**2025 BIGY 190 FACTORY DAYTONA XL
 FIRST TO THE FINISH LINE**

POINTS FORTS & NOUVEAUTÉS 2025

SURMOUSSE DE GUIDON CAOUTCHOUC 3D
MOTEUR 4 VITESSES DAYTONA
BRAS OSCILLANT ALUMINIUM
REPOSE PIED INOX
BAVETTE AMORTISSEUR
GUIDON YCF 28,6MM
TÉ FOURCHE SUPÉRIEUR 3 POSITIONS
NOUVELLE BOÎTE AIR
NOUVEAU SILENCIEUX
NOUVEAU PATIN CHAÎNE
NOUVEAU GUIDE CHAÎNE
NOUVEAU RÉSERVOIR

HIGHLIGHTS & 2025 NEW FEATURES

RUBBER BAR PAD
 DAYTONA 4 SPEED ENGINE
 ALUMINUM SWING ARM
 INOX FOOTPEGS
 MUD FLAP
 YCF FAT BAR 28.6mm HANDLEBAR
 UPPER CLAMP 3 POSITIONS BAR MOUNT
 NEW AIRBOX
 NEW MUFFLER
 NEW CHAIN SLIDER
 NEW CHAIN GUIDE
 NEW TANK

bigX^{XL} 190
FACTORY

DAYTONA



910 mm / 36 in.

 **88,90Kg / 185 lbs**

L : 780mm / W : 31 in.

1325mm / 52 in.

1945mm / 76 in.



€2099

SPÉCIFICATIONS

MOTEUR: MONO CYLINDRE 4 TEMPS 125cc
4 VITESSES EMBRAYAGE
FOURCHE INVERSÉE 660mm
SUSPENSION ARRIÈRE RÉGLABLE 270mm
PNEUS AV. & AR.: 100/90/12 - 120/80/12

SPECIFICATIONS

ENGINE TYPE: SINGLE CYLINDER 4 STROKE 125cc
 4 GEARS (N1234)
 660mm UPSD FORK
 270mm ADJUSTABLE REAR SUSPENSION
 FRONT & REAR TIRES: 100/90/12 - 120/80/12

**2025 SM 125
 SUPERMOTO, SUPER FUN!**

POINTS FORTS & NOUVEAUTÉS 2025

MOTEUR 125 ZONGSHEN FIDDY RACER
ROUES YCF
SELLE BASSE COMPATIBLE PAGE 92
KIT RABAISSE ADAPTABLE PAGE 104
TÉ FOURCHE SUPÉRIEUR 3 POSITIONS
CARBURATEUR NIBBI PE24SP
NOUVELLE SELLE

HIGHLIGHTS & 2025 NEW FEATURES

ZONGSHEN ENGINE 125 FIDDY RACER
 YCF WHEELS
 COMPATIBLE LOW SEAT PAGE 92
 HEIGHT ADJUSTMENT KIT PAGE 104
 UPPER CLAMP 3 POSITIONS BAR MOUNT
 NIBBI PE24SP CARBURETOR
 NEW SEAT

M 125



780mm/ 30 in.

 69Kg/ 152 lbs

L : 740mm/ W: 29 in.

1120mm/ 44 in.

1610mm/ 63 in.



€2599

SPÉCIFICATIONS

MOTEUR: MONO CYLINDRE
4 TEMPS 155cc ZONGSHEN/ 4 VITESSES (N1234)
FOURCHE INVERSÉE 735mm
SUSPENSION ARRIÈRE RÉGLABLE 310mm
PNEUS AV. & AR. : 100/90/12 - 120/80/12

SPECIFICATIONS

ENGINE TYPE: SINGLE CYLINDER
4 STROKE ZONGSHEN 155cc/ 4 GEARS (N1234)
735mm UPSD FORK
310mm ADJUSTABLE REAR SUSPENSION
FRONT & REAR TIRES: 100/90/12 - 120/80/12

2025 SM 155 ADRENALINE RUSH

POINTS FORTS & NOUVEAUTÉS 2025

MOTEUR ZONGSHEN® W155
ROUES YCF
FILTRE À AIR YCF
FOURCHE RÉGLABLE
TÉ FOURCHE SUPÉRIEUR 3 POSITIONS
CARBURATEUR NIBBI PE24SP
NOUVEAU PATIN CHAÎNE
NOUVEAU GUIDE CHAÎNE

HIGHLIGHTS & 2025 NEW FEATURES

ZONGSHEN® ENGINE W155
YCF WHEELS
YCF AIR FILTER
ADJUSTABLE FRONT FORK
UPPER CLAMP 3 POSITIONS BAR MOUNT
NIBBI PE24SP CARBURETOR
NEW CHAIN SLIDER
NEW CHAIN GUIDE



800mm/ 32 in.

 70Kg/ 154 lbs

L : 740mm/ W: 29 in.

1170mm/ 46 in.

1680mm/ 66 in.



€3599

SPÉCIFICATIONS

MOTEUR: MONO CYLINDRE 4T, 4 SOUPAPES 190cc
DAYTONA® ANIMA® / 4 VITESSES (N1234)
FOURCHE ENGI® INVERSÉE RÉGLABLE 735mm
SUSPENSION ARRIÈRE DNM® RÉGLABLE 310mm
PNEUS AV. & AR. 100/90/12 - 120/80/12
CARBURATEUR NIBBI® PE28

SPECIFICATIONS

ENGINE TYPE: DAYTONA® ANIMA® SINGLE CYLINDER 4V
 4 STROKE 190cc/ 4 GEARS (N1234)
 735mm ENGI® UPSD ADJUSTABLE FORK
 310mm DNM® ADJUSTABLE REAR SUSPENSION
 FRONT & REAR TIRES: 100/90/12 - 120/80/12
 NIBBI® PE28 CARBURETOR

DAYTONA ENGI® KENDA

2025 SM 190 DAYTONA
CATCH ME IF YOU CAN (ON ROAD)

POINTS FORTS & NOUVEAUTÉS 2025

ROUES YCF
LIGNE D'ÉCHAPPEMENT RACING DOUBLE SORTIE
AMORTISSEUR DNM 1000LBS
MAÎTRE CYLINDRE AVANT RACING
KIT FREIN RADIAL AVANT ET ARRIÈRE
DISQUE FLOTTANT 220MM
TÉ FOURCHE SUPÉRIEUR 3 POSITIONS
NOUVEAU SILENCIEUX
NOUVEAU PATIN CHÂÎNE
NOUVEAU GUIDE CHÂÎNE

HIGHLIGHTS & 2025 NEW FEATURES

YCF WHEELS
 COMPLETE RACING EXHAUST TWIN
 DNM SHOCK ABSORBER 1000 LBS
 FRONT RACING MASTER CYLINDER
 FRONT AND REAR RADIAL BRAKE KIT
 SEMI FLOATING BRAKE ROTOR 220MM
 UPPER CLAMP 3 POSITIONS BAR MOUNT
 NEW MUFFLER
 NEW CHAIN SLIDER
 NEW CHAIN GUIDE

F190

F190
DAYTONA



820mm/ 32 in.

 **79Kg/ 174 lbs**

L : 740mm/ W: 29 in.

1160mm/ 45 in.

1640mm/ 64 in.



€3499

2025 GP 124 WARM-UP

SPÉCIFICATIONS

SPECIFICATIONS

MOTEUR :
MONO CYLINDRE 4T ZONGSHEN® 125CC FIDDY RACER
FOURCHE INVERSÉE YCF® NON RÉGLABLE 650MM
AMORTISSEUR YCF® RÉGLABLE DÉTENTE 310MM
PNEUS PMT AV & AR 100/90/12 - 120/80/12
ROUES YCF® ALUMINIUM AV & AR 2.15/12 & 2.75/12
TÉ DE FOURCHE 160MM
CARBURATEUR NIBBI® PZ18

ENGINE TYPE :
 ZONGSHEN® 125cc FIDDY RACER
 YCF® 650MM NON ADJUSTABLE FRONT FORK
 310MM YCF® ADJUSTABLE REBOUND SHOCK ABSORBER
 TIRES FRONT & REAR 100/90-12 & 120/80/12
 YCF® ALUMINIUM WHEEL 2.15/12 FRONT & 2.75/12 REAR
 160MM TRIPLE CLAMP
 CARBURETOR NIBBI® PZ18

POINTS FORTS & NOUVEAUTÉS 2025

HIGHLIGHTS & 2025 NEW FEATURES

CADRE ALUMINIUM
BOUCLE ARRIÈRE ALUMINIUM
BRAS OSCILLANT ALUMINIUM
DISQUE FREIN AVANT FLOTTANT 220MM
ÉTRIER FREIN AVANT RADIAL 4 PISTONS
CARÉNAGE SOUPLE
COMMANDES REÇULÉES RÉGLABLES
GUIDON BRACELET RÉGLABLE
DIABOLOS DE BÉQUILLE AVANT & ARRIÈRE
TENDEURS DE CHAÎNE MINI GP
BOUCHON RÉSERVOIR ALUMINIUM FERMETURE RAPIDE
ÉCHAPPEMENT BAS
SABOT RÉCUPÉRATEUR D'HUILE ÉTANCHE
LIVRÉ AVEC UNE BÉQUILLE DE STAND
NOUVEAU RÉSERVOIR

ALUMINIUM FRAME
 ALUMINIUM SUBFRAME
 ALUMINIUM SWING ARM
 220MM FLOATING FRONT DISC
 RADIAL 4-PISTON FRONT BRAKE CALIPER
 FLEXIBLE FAIRING
 FULLY ADJUSTABLE REARSETS
 FULLY ADJUSTABLE HANDLEBAR
 FRONT & REAR SPOOL
 MINI GP BLOCK AXLE
 QUICK RELEASE GAS CAP
 BELLY EXHAUST SYSTEM
 BELLY PAN
 INCLUDES BIKE STAND
 NEW TANK



GP124



 72,4Kg / 158 lbs

L : 690mm / W : 27 in.

1170mm / 46 in.

1665mm / 65 in.



€3999

SPÉCIFICATIONS

MOTEUR: MONO CYLINDRE 4T, ZONGSHEN® 155cc
MONO CYLINDRE 4T, 4 VITESSES (N1234)
FOURCHE INVERSÉE YCF® RÉGLABLE
COMPRESSION/ DÉTENTE 650MM
AMORTISSEUR DNM RÉGLABLE COMPRESSION/
DÉTENTE 310MM
PNEUS PMT AV & AR 100/90/12 - 120/80/12
ROUES YCF® ALUMINIUM AV & AR 2.15/12 & 2.75/12
TÉ DE FOURCHE 160MM
CARBURETEUR NIBBI® PE24

SPECIFICATIONS

ENGINE TYPE : ZONGSHEN® 155cc
 4 SPEED (N1234)
 YCF® 650MM FULLY ADJUSTABLE COMPRESSION/
 REBOUND FRONT FORK
 DNM ADJUSTABLE SHOCK ABSORBER WITH
 COMPRESSION/REBOUND SETTINGS, 310MM
 PMT TIRES FRONT & REAR 100/90-12 & 120/80/12
 YCF® ALUMINIUM WHEEL 2.15/12 FRONT & 2.75/12 REAR
 160MM TRIPLE CLAMP
 CARBURETOR NIBBI® PE24

2025 GP 157 APEX

POINTS FORTS & NOUVEAUTÉS 2025

CADRE ALUMINIUM
BOUCLE ARRIÈRE ALUMINIUM
BRAS OSCILLANT ALUMINIUM
DISQUE FREIN AVANT FLOTTANT 220MM
ÉTRIER FREIN AVANT RADIAL 4 PISTONS
CARÉNAGE SOUPLE
COMMANDES REÇULÉES RÉGLABLES
GUIDON BRACELET RÉGLABLE
DIABOLOS DE BÉQUILLE AVANT & ARRIÈRE
TENDEURS DE CHAÎNE MINI GP
BOUCHON RÉSERVOIR ALUMINIUM FERMETURE RAPIDE
ÉCHAPPEMENT BAS
SABOT RÉCUPERATEUR D'HUILE ÉTANCHE
LIVRÉ AVEC UNE BÉQUILLE DE STAND
NOUVEAU RÉSERVOIR

HIGHLIGHTS & 2025 NEW FEATURES

ALUMINIUM FRAME
 ALUMINIUM SUBFRAME
 ALUMINIUM SWING ARM
 220MM FLOATING FRONT DISC
 RADIAL 4-PISTON FRONT BRAKE CALIPER
 FLEXIBLE FAIRING
 FULLY ADJUSTABLE REARSETS
 FULLY ADJUSTABLE HANDLEBAR
 FRONT & REAR SPOOL
 MINI GP BLOCK AXLE
 QUICK RELEASE GAS CAP
 BELLY EXHAUST SYSTEM
 BELLY PAN
 INCLUDES BIKE STAND
 NEW TANK



GP157



 **75Kg/ 165 lbs**

L : 690mm/ W: 27 in.

1170mm/ 46 in.

1665mm/ 65 in.



€4699

2025 GP 187 DAYTONA HOLESHOT

SPÉCIFICATIONS

MOTEUR: DAYTONA® ANIMA/ 4 VITESSES (N1234)
MONO CYLINDRE 4T, 4 SOUPAPES 190cc
**FOURCHE INVERSÉE YCF® RÉGLABLE COMPRESSION/
 DÉTENTE 650MM**
**AMORTISSEUR DNM® RÉGLABLE COMPRESSION/
 DÉTENTE 310MM**
PNEUS AV & AR 100/90/12 - 120/80/12
ROUES YCF® ALUMINIUM AV & AR 2.15/12 & 2.75/12
TÉ DE FOURCHE 160MM
CARBURATEUR NIBBI® PE28

SPECIFICATIONS

ENGINE TYPE : DAYTONA® ANIMA SINGLE CYLINDER 4V
 4 STROKE 190cc/ 4 SPEED (N1234)
 YCF® 650MM FULLY ADJUSTABLE COMPRESSION/
 REBOUND FRONT FORK
 310MM DNM® ADJUSTABLE COMPRESSION/
 REBOUND SHOCK ABSORBER
 TIRES FRONT & REAR 100/90-12 & 120/80/12
 YCF® ALUMINIUM WHEEL 2.15/12 FRONT & 2.75/12 REAR
 160MM TRIPLE CLAMP
 CARBURETOR NIBBI® PE28

POINTS FORTS & NOUVEAUTÉS 2025

CADRE ALUMINIUM
BOUCLE ARRIÈRE ALUMINIUM
BRAS OSCILLANT ALUMINIUM
DISQUE FREIN AVANT FLOTTANT 220MM
ÉTRIER FREIN AVANT RADIAL 4 PISTONS
CARÉNAGE SOUPLE
COMMANDES REÇULÉES RÉGLABLES
GUIDON BRACELET RÉGLABLE
DIABOLOS DE BÉQUILLE AVANT & ARRIÈRE
TENDEURS DE CHAÎNE MINI GP
BOUCHON RÉSERVOIR ALUMINIUM FERMETURE RAPIDE
ÉCHAPPEMENT BAS
SABOT RÉCUPÉRATEUR D'HUILE ÉTANCHE
LIVRÉ AVEC UNE BÉQUILLE DE STAND
NOUVEAU RÉSERVOIR

HIGHLIGHTS & 2025 NEW FEATURES

ALUMINIUM FRAME
 ALUMINIUM SUBFRAME
 ALUMINIUM SWING ARM
 220MM FLOATING FRONT DISC
 RADIAL 4-PISTON FRONT BRAKE CALIPER
 FLEXIBLE FAIRING
 FULLY ADJUSTABLE REARSETS
 FULLY ADJUSTABLE HANDLEBAR
 FRONT & REAR SPOOL
 MINI GP BLOCK AXLE
 QUICK RELEASE GAS CAP
 BELLY EXHAUST SYSTEM
 BELLY PAN
 INCLUDES BIKE STAND
 NEW TANK



GP 187 DAYTONA®



715mm/ 28 in.

 76,2Kg/ 167 lbs

L : 690mm/ W: 27 in.

1170mm/ 46 in.

1665mm/ 65 in.



GP PLASTIQUES
YCF PLASTICS



CARÉNAGE DROIT
RIGHT SIDE FAIRING

N° YC110-1432-02-BKM
N° YC110-1432-02-WH



PROTECTION AVANT
FRONT GUARD

N° YC110-1445-BKM



GARDE BOUE AVANT
FRONT FENDER

N° YC110-0302-01-BKM
N° YC110-0302-01-WH



CARÉNAGE GAUCHE
LEFT SIDE FAIRING

N° YC110-1433-02-BKM
N° YC110-1433-02-WH



CARÉNAGE AVANT
FRONT FAIRING

01 N° YC110-0212-13-BKM
01 N° YC110-0212-13-WH
02 N° YC110-0941(VIS PLASTIQUE/ PLASTIC SCREW)



COUVRE RÉSERVOIR
GAS TANK COVER

N° YC110-1402-06-BKM
N° YC110-1402-06-WH



GARDE BOUE ARRIÈRE
REAR FENDER

N° YC110-0460-02-BKM

GP PIÈCES MOTEUR GP ENGINE PARTS



COQUE ARRIÈRE NOIRE, BLANCHE, ORANGE, JAUNE, VERTE
REAR SEAT BLACK, WHITE, ORANGE, YELLOW, GREEN

N° YC110-1402-07-BKM
N° YC110-1402-07-WH
N° YC110-1402-07-OR
N° YC110-1402-07-YE
N° YC110-1402-07-GR



SUPPORT DE CARÈNAGE
FAIRING SUPPORT

N° YC110-1444-BKM



SUPPORT TÊTE DE FOURCHE
STEEL FRONT FAIRING SUPPORT MATT BLACK

N° YC110-0738-BKM



SELLE
SEAT PAD FOAM MATTE BLACK

N° YC110-1401-20-BKM



PASSAGE DE ROUE
REAR UNDERTAIL

N° YC110-1402-08-BKM



SABOT MOTEUR
BELLY PAN

N° YC110-0905-04-BKM

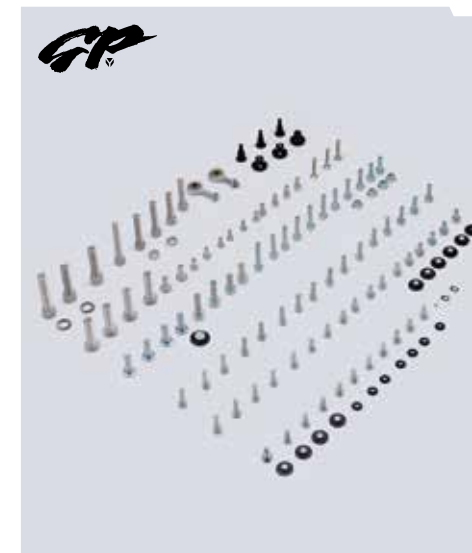

BOÎTE DE VIS GP
GP BOLT SCREW KIT

N° KVP-7

PIÈCES GP GP PARTS



TUBE DE GUIDON
CLIP-ON BAR

- 01 N° YC110-0101-2501-BKM
- 02 N° YC110-0153-02-BKM (EMBOU DE GUIDON)



POIGNÉES CAOUTCHOUC GP
GP RUBBER GRIPS

N° PPC012-BK



COUPE CIRCUIT AIMANTÉ
MAGNET KILL SWITCH

- 01 N° YC110-0105-07 (GP187)
- 02 N° YC110-0105-08 (GP107-GP157)

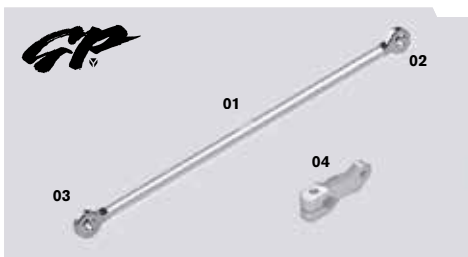

TIGE DE SELECTEUR COMPLET
COMPLETE SHIFT LINKAGE

- 01 N° YC110-0931-ZH-SI
- 02 N° YC110-0939-01
- 03 N° YC110-0939-02
- 04 N° YC110-0932-SI



PÉDALE DE FREIN ALUMINIUM
ALUMINIUM BRAKE PEDAL

N° YC110-0938-SI



**JEU DE FOURCHE NON RÉGLABLE L=650mm
POUR GP107 ET RÉGLABLE COMPRESSION/DÉTENTE
L=650mm POUR GP157/ GP187**

PAIR OF FORK L: 650MM NOT ADJUSTABLE TITANIUM FOR GP107 & FORK L: 650MM ADJUSTABLE COMPRESSION / REBOUND TITANIUM FOR GP157 / GP187

- 01 N° YC110-0400-45-TI (GP107)
- 02 N° YC110-0400-44-TI (GP157-GP187)

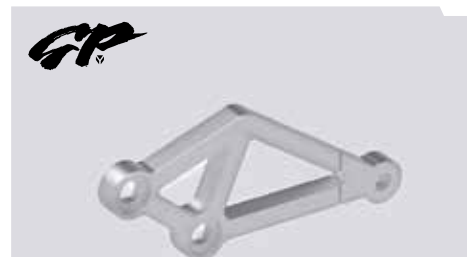

PLATINE ALUMINIUM DE REPOSE PIED GAUCHE
LEFT ALUMINIUM FOOTPEG SUPPORT

N° YC110-0933-SI



PÉDALE DE SÉLECTEUR ALUMINIUM
ALUMINIUM GEARSHIFT PEDAL

N° YC110-0934-SI

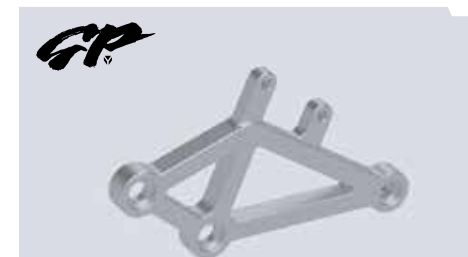

PLATINE ALUMINIUM DE REPOSE PIED DROIT
RIGHT ALUMINIUM FOOTPEG SUPPORT

N° YC110-0935-SI



AMORTISSEUR
SHOCK ABSORBER

- 01 N° YC110-0404-17 GP107 2024
- 02 N° YC110-0404-98 GP124 2025/ GP157 2024
- 03 N° YC110-0404-35 GP157 2025/ GP187 2024-25



BOUCHON RÉSERVOIR RAPIDE COMPLET
ALUMINIUM QUICK RELEASE GAS CAP

N° YC110-0721





FILTRE À AIR
AIR FILTER

N° KL-ZT-HP-55



GUIDE CHAÎNE
CHAIN GUIDE ASSEMBLY

01 N° YC110-1004-01 (2024)
02 N° YC110-1005



EMBOUIT TÉFLON DE REPOSE PIED
MINI GP FOOT PEG SLIDER

N° YC110-1037-BK



JEUX DE TENDEURS DE CHAÎNE
AXLE BLOCK ADJUSTER

N° YC110-1021-MG € 39



DIABOLO TEFLON
SPOOL TEFLON MATT BLACK

N° YC110-1035-02-BK



ÉCHAPEMENT COMPLET
COMPLETE MINIGP SINGLE RACING MUFFLER & EXHAUST FOR GP107/ GP157/ GP187

N° YC110-139-15 (GP 107)
N° YC110-139-14 (GP 157)
N° YC110-139-13 (GP 187)



RÉSERVOIR
GAS TANK

N° YC110-0701-08



REPOSE PIEDS ALUMINIUM
ALUMINUM FOOTPEGS KIT

N° YC110-0902-18-SI



EMBOUIT DE TÉFLON DE SÉLECTEUR/ PÉDALE DE FREIN
POM GEARSHIFT END CAP/ BRAKE FOOTPEG

N° YC110-0903-11

PIÈCES RACING GP GP RACING PARTS

GP



BÉQUILLE AVANT/ ARRIÈRE
FRONT/ REAR STAND

N° STAND1MOTO-04

GP



T-SHIRT GP (TAILLE: S/ M/ L/ XL/ XXL)
GP T-SHIRT (SIZE: S/ M/ L/ XL/ XXL)

N° TSGPBK+TAILLE/SIZE
N° TSFGPBK+TAILLE/SIZE (S/ M FEMME/ WOMEN)

GP



PAIRE DE COUVERTURE CHAUFFANTE AVEC BOITIER DE RÉGLAGE INDEPENDANT JUSQU'À 99 DEGRES
TIRE WARMERS WITH INDEPENDANT ADJUSTABLE TEMPERATURE CONTROL (UP TO 99 DEGREES)

N° YC110-1125-01-BK

GP



KIT FREIN AVANT RADIAL 2 PISTONS L: 775MM
RADIAL FRONT BRAKE ASSY 2 PUMPS L: 775MM

01 N° YC110-0512-10
02 N° YC110-0506-01

GP



KIT FREIN ARRIÈRE D10/10 L: 365mm
REAR BRAKE ASSY D10/10 L: 365MM

01 N° YC110-1212-10
02 N° YC110-1204-02

GP



FREIN ARRIÈRE AU GUIDON GP
REAR BRAKE HANDLE BAR GP

N° YC110-12012-34

GP



KIT FREIN ARRIÈRE AU POUCE
THUMB BRAKE

N° YC110-1212-13



**PADDOCK
PADDOCK**



ORIFLAMME
FLAG

N° YCF-FLAG-3M (3 METERS-118 in.)

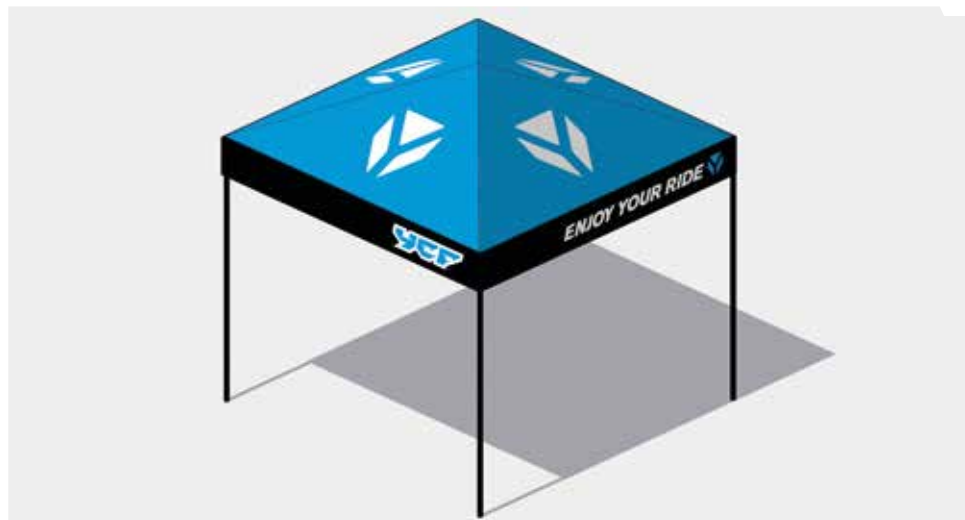

TONNELLE 3 X 3M YCF (100% ÉTANCHE) VELCRO INTÉGRAL AUTOUR DU TOIT
YCF PIT TENT 3 X 3M (100% WATERPROOF) INTEGRAL VELCRO AROUND THE ROOF

N° TONNELLEYCF-4



RUBALISE DE TERRAIN (ROULEAU DE 100 MÈTRES)
BANNER ROLL (100 METERS ROLL)

N° RUB-1



BANDEROLE DE TERRAIN EN FEUTRINE 1 X 25M
BANNER ROLL 1 X 25M

N° FEUTRINE-1



BANNER YCF 2 X 0,50M
YCF BANNER 2 X 0,50M

N° BANNER-01



BÂCHE MOTO
MOTORCYCLE COVER

N° BIKECOVER-BL



CÔTÉ DE TONNELLE 3 X 3M AVEC PORTE ZIPPÉE
PIT TENT SIDE 3 X 3M WITH ZIP DOOR

01 N° PORTE-1

DEMI CÔTÉ DE TONNELLE
PIT TENT HALF SIDE

02 N° DEMICOTE-1-BL

CÔTÉ DE TONNELLE 3 X 3M
PIT TENT SIDE 3 X 3M

03 N° COTE-1-BL



CHAISE PLIABLE YCF
YCF FOLDING CHAIR

N° CHAIR-BK



TRÉPIED ALUMINIUM NOIR/ BLEU/ VERT/ ORANGE/ ROUGE - HAUTEUR 40 cm
ALUMINUM BIKE STAND BLACK/ BLUE/ GREEN/ ORANGE/ RED - HEIGHT 15,7 in.

N° TREPIED-COLOR



BÉQUILLE ROUE AR RÉGLABLE AVEC ROULETTES
REAR STAND. COMES WITH HEIGHT ADJUSTABLE FORKS FOR SPOOLS

N° STAND1MOTO-04



TAPIS SOL ENVIRONNEMENTAL YCF 180X80 CM
ENVIRONMENTAL YCF RUBBER MAT 180X80 CM (70in x 31 in.)

N° TAPISSOL-4



TRÉPIED ACIER NOIR pour 50/88 - HAUTEUR 32 cm
50/88 STEEL BIKE STAND BLACK - HEIGHT 12 in.

N° TREPIED02-BK



TRÉPIED ACIER NOIR - HAUTEUR 40 cm
STEEL BIKE STAND BLACK - HEIGHT 15,7 in.

N° TREPIED01-BK



BÉQUILLE ROUE AR RÉGLABLE
ADJUSTABLE REAR WHEEL STAND

N° STAND1MOTO-02



SAC À DOS YCF
YCF BACKPACK

N° BACKPACKYCF-GY



SAC DE TRANSPORT 54X32X32cm
DUFFLE BAG 54X32X32cm

N° BAGYCF-BL



CHAPEAU YCF
YCF STRAW HAT

N° STHYCF



BOB YCF
YCF BUCKET HAT

N° BOB-BK

GRAPHICS & PLASTICS



ACCESSOIRES PLASTIQUES

KITS DÉCO / GRAPHIC KITS	70
PERSONNALISATION / CUSTOMIZATION	75
KITS PLASTIQUES / PLASTIC KITS	76

RACING KITS DÉCO/ GRAPHIC KITS

3M

⚠ KIT COMPLET POUR GAMME 2007 À 2025
COMPLETE KIT FOR RANGE 2007 TO 2025



⚠
KIT DÉCO RACING JAUNE/ NOIR pour LITE/ START/ PILOT/ FACTORY/ SM
GRAPHICS KIT RACING YELLOW/ BLACK for LITE/ START/ PILOT/ FACTORY/ SM

N° KD-AFT22-BK



⚠
KIT DÉCO RACING VERT/ ROUGE pour LITE/ START/ PILOT/ FACTORY/ SM
GRAPHICS KIT RACING GREEN/ RED for LITE/ START/ PILOT/ FACTORY/ SM

N° KD-AFT22-GR



KIT DÉCO DE CADRE POUR FACTORY
GRAPHIC KIT FOR FACTORY FRAME

N° FGKFP-BK



⚠
KIT DÉCO RACING BLEU/ BLANC pour LITE/ START/ PILOT/ FACTORY/ SM
GRAPHICS KIT RACING BLUE/ WHITE for LITE/ START/ PILOT/ FACTORY/ SM

N° KD-AFT22-BL



⚠
KIT DÉCO RACING ROUGE/ BLEU pour LITE/ START/ PILOT/ FACTORY/ SM
GRAPHICS KIT RACING RED/ BLUE for LITE/ START/ PILOT/ FACTORY/ SM

N° KD-AFT22-RD



KIT DÉCO DE CADRE POUR PILOT
GRAPHIC KIT FOR PILOT FRAME

N° FGKP-BK

**NEW
2025**



ORIGINAL YCF® KITS DÉCO/ GRAPHIC KITS



KIT DÉCO 50A YCF 2025
50A YCF GRAPHIC KIT 2025

N° KD50A2025 (50 SEULEMENT/ ONLY)



KIT DÉCO 50E YCF 2025
50E YCF GRAPHIC KIT 2025

N° KD50E2025 (50 SEULEMENT/ ONLY)



KIT DÉCO LITE 88 2025
GRAPHIC KIT LITE 88 2025

N° KD88L2025



KIT DÉCO LITE 125 2025
GRAPHIC KIT LITE 125 2025

N° KD125L2025



KIT DÉCO START W88E 2025
GRAPHIC KIT START W88E 2025

N° KD88E2025



KIT DÉCO START 88SE 2025
GRAPHIC KIT START 88SE 2025

N° KD88SE2025



KIT DÉCO START 125 2025
GRAPHIC KIT START 125 2025

N° KD1252025



KIT DÉCO START 125SE 2025
GRAPHIC KIT START 125SE 2025

N° KD125SE2025



KIT DÉCO PILOT 125 2025
GRAPHIC KIT PILOT 125 2025

Nº KDP1252025



KIT DÉCO PILOT 150E 2025
GRAPHIC KIT PILOT 150E 2025

Nº KDP150E2025



KIT DÉCO SM 125 2025
GRAPHIC KIT SM 125 2025

Nº KDSM1252025



KIT DÉCO FACTORY SP2 2025
GRAPHIC KIT FACTORY SP2 2025

Nº KDSP22025



KIT DÉCO FACTORY SP3 190 2025
GRAPHIC KIT FACTORY SP3 190 2025

Nº KDSP31902025



KIT DÉCO SM 155 2025
GRAPHIC KIT SM 155 2025

Nº KDSM1552025



KIT DÉCO SM 190 2025
GRAPHIC KIT SM 190 2025

Nº KDSM1902025

**NEW
2025**



**ORIGINAL YCF®
KITS DÉCO/ GRAPHIC KITS**



KIT DÉCO BIGY 125 MX 2025
GRAPHIC KIT BIGY 125 MX 2025

N° KDBIGY1252025



KIT DÉCO BIGY 150 MX 2025
GRAPHIC KIT BIGY 150 MX 2025

N° KDBIGY1502025



KIT DÉCO BIGY FACTORY 150 MX-E XL 2025
GRAPHIC KIT BIGY FACTORY 150 MX-E XL 2025

N° KDBIGYF150EXL25



KIT DÉCO BIGY FACTORY 190 MX DAYTONA® XL 2025
GRAPHIC KIT BIGY FACTORY 190 MX DAYTONA® XL 2025

N° KDBIGYFD190XL25



KIT DÉCO RACING JAUNE/ NOIR pour BIGY
 GRAPHIC KIT RACING YELLOW/ BLACK for BIGY

N° KDBIGY-AFT22-BK



KIT DÉCO RACING VERT/ ROUGE pour BIGY
 GRAPHIC KIT RACING GREEN/ RED for BIGY

N° KDBIGY-AFT22-GR



KIT DÉCO RACING BLEU/ BLANC pour BIGY
 GRAPHIC KIT RACING BLUE/ WHITE for BIGY

N° KDBIGY-AFT22-BL



KIT DÉCO RACING ROUGE/ BLEU pour BIGY
 GRAPHIC KIT RACING RED/ BLUE for BIGY

N° KDBIGY-AFT22-RD

PERSONNALISATION CUSTOMIZATION

31 968 COMBINAISONS

2 COULEURS DE PLAQUES (PLASTIQUE)
8 COULEURS DE FONDS DE PLAQUES
999 CHIFFRES (DESIGN YCF)
2 COULEURS DE CHIFFRES

YCF ID 1.0 EST LA 1^{ÈRE} ÉTAPE DU PROGRAMME DE PERSONNALISATION DE VOTRE MOTO YCF, VOUS POUVEZ MAINTENANT CRÉER VOTRE PLAQUE NUMÉRO ORIGINALE GRÂCE À UN LARGE CHOIX DE DESIGNS GRAPHIQUES ET DE COULEURS.

DISPONIBLE CHEZ VOTRE REVENDEUR.

31,968 COMBINATIONS

2 (PLASTIC) PLATE COLORS
8 BACKGROUND PLATE COLORS
999 INDIVIDUAL CHARACTERS (YCF DESIGN)
2 COLORS AVAILABLE

YCF ID 1.0 IS THE FIRST STAGE OF THE CUSTOMIZATION PROCESS FOR YOUR YCF MINI-BIKE. YOU CAN NOW CREATE YOUR OWN ORIGINAL NUMBER PLATE THANKS TO A WIDE CHOICE OF GRAPHIC DESIGNS AND COLOR.

AVAILABLE AT YOUR RETAILER.



NUMÉRO POUR 3 PAR PLAQUE
NUMBERS FOR 3 PER PLATE

01 N° NUM.NUMBER/8CM (NOIR/ BLACK)
01 N° NUMW. NUMBER/8CM (BLANC/ WHITE) (x3)

NUMÉRO POUR 2 PAR PLAQUE
NUMBERS FOR 2 PER PLATE

02 N° NUM.NUMBER/11CM (NOIR/ BLACK)
02 N° NUMW.NUMBER/11CM (BLANC/ WHITE) (x3)

NUMÉRO POUR 1 PAR PLAQUE
NUMBERS FOR 1 PER PLATE

03 N° NUM.NUMBER/18CM (NOIR/ BLACK)
03 N° NUMW.NUMBER/18CM (BLANC/ WHITE) (x3)



N° STSVYCF-01

KITS PLASTIQUES YCF

YCF PLASTIC KITS



**PLAQUE AVANT POUR LITE 88 2020-25/ LITE 125/ START 88SE 2020-25/ START 125/ PILOT/ FACTORY/ SM
NOIRE/ BLEUE/ ROUGE/ VERTE/ JAUNE/ ORANGE/ ROSE/ BLANCHE/ GRISE**

FRONT NUMBER PLATE FOR LITE 88 2020-25/ LITE 125/ START 88SE 2020-25/ START 125/ PILOT/ FACTORY/ SM
BLACK/ BLUE/ RED/ GREEN/ YELLOW/ ORANGE/ PINK/ WHITE/ GREY

N° YC110-0212-07+COLOR



**GARDE BOUE AVANT POUR LITE 125/ START 125/ PILOT/ FACTORY/ SM (2014-2025)/ START 88SE 2021
NOIR/ BLEU/ ROUGE/ VERT/ JAUNE/ ORANGE/ ROSE/ BLANC/ GRIS**

FRONT FENDER FOR LITE 125/ START 125/ PILOT/ FACTORY/ SM (2014-2025)/ START 88SE 2021
BLACK/ BLUE/ RED/ GREEN/ YELLOW/ ORANGE/ PINK/ WHITE/ GREY

N° YC110-032-02+COLOR



**OUIE RADIATEUR DROITE EN 2 PARTIES POUR PILOT 2018-25/ FACTORY 2017-25/ START 2020-25
NOIRE/ BLEUE/ ROUGE/ VERTE/ JAUNE/ ORANGE/ BLANCHE/ GRISE/ ROSE**

RIGHT SHROUD 2 PARTS FOR PILOT 2018-25/ FACTORY 2017-25/ START 2020-2025
BLACK/ BLUE/ RED/ GREEN/ YELLOW/ ORANGE/ WHITE/ GREY/ PINK

N° YC110-14-059-COLOR



**OUIE RADIATEUR GAUCHE EN 2 PARTIES POUR PILOT 2018-25/ FACTORY 2017-25/ START 2020-25
NOIRE/ BLEUE/ ROUGE/ VERTE/ JAUNE/ ORANGE/ BLANCHE/ GRISE/ ROSE**

LEFT SHROUD 2 PARTS FOR PILOT 2018-25/ FACTORY 2017-25/ START 2020-25
BLACK/ BLUE/ RED/ GREEN/ YELLOW/ ORANGE/ WHITE/ GREY/ PINK

N° YC110-14-069-COLOR



PLAQUE LATÉRALE DROITE POUR LITE/ START 2017-2025/ PILOT 2007-2015/ FACTORY 2007-2015
NOIRE/ BLEUE/ ROUGE/ VERTE/ JAUNE/ ORANGE/ ROSE/ BLANCHE/ GRISE

RIGHT NUMBER PLATE FOR LITE/ START 2017-2025/ PILOT 2007-2015/ FACTORY 2007-2015
 BLACK/ BLUE/ RED/ GREEN/ YELLOW/ ORANGE/ PINK/ WHITE/ GREY

Nº YC110-14-022+COLOR



PLAQUE LATÉRALE GAUCHE POUR LITE/ START 2017-2025/ PILOT 2007-2015/ FACTORY 2007-2015
NOIRE/ BLEUE/ ROUGE/ VERTE/ JAUNE/ ORANGE/ ROSE/ BLANCHE/ GRISE

LEFT NUMBER PLATE FOR LITE/ START 2017-2025/ PILOT 2007-2015/ FACTORY 2007-2015
 BLACK/ BLUE/ RED/ GREEN/ YELLOW/ ORANGE/ PINK/ WHITE/ GREY

Nº YC110-14-042+COLOR



PLAQUE LATÉRALE DROITE POUR PILOT 2016-25/ FACTORY 2016-25
NOIRE/ BLEUE/ ROUGE/ VERTE/ JAUNE/ ORANGE/ BLANCHE/ GRISE/ ROSE

RIGHT NUMBER PLATE FOR PILOT 2016-25/ FACTORY 2016-25
 BLACK/ BLUE/ RED/ GREEN/ YELLOW/ ORANGE/ WHITE/ GREY/ PINK

Nº YC110-14-028+COLOR



PLAQUE LATÉRALE GAUCHE POUR PILOT 2016-25/ FACTORY 2016-25
NOIRE/ BLEUE/ ROUGE/ VERTE/ JAUNE/ ORANGE/ BLANCHE/ GRISE/ ROSE

LEFT NUMBER PLATE FOR PILOT 2016-25/ FACTORY 2016-25
 BLACK/ BLUE/ RED/ GREEN/ YELLOW/ ORANGE/ WHITE/ GREY/ PINK

Nº YC110-14-048+COLOR



**GARDE BOUE ARRIÈRE POUR LITE/ START 2007-2025/ PILOT 2007-2015/ FACTORY 2007-2015
NOIR/ BLEU/ ROUGE/ VERT/ JAUNE/ ORANGE/ ROSE/ BLANC/ GRIS**

REAR FENDER FOR LITE/ START 2007-2025/ PILOT 2007-2015/ FACTORY 2007-2015
BLACK/ BLUE/ RED/ GREEN/ YELLOW/ ORANGE/ PINK/ WHITE/ GREY

Nº YC110-14-012+COLOR



**PAIRE DE PROTECTIONS FOURCHE (ADAPTABLE SUR TOUTES LES FOURCHES)
NOIRES/ BLEUES/ ROUGES/ VERTES/ JAUNES/ ORANGES/ BLANCHES/ ROSE**

PAIR OF FORK GUARD (WITH SLOTTED HOLE ADAPTABLE TO ALL FORKS)
BLACK/ BLUE/ RED/ GREEN/ YELLOW/ ORANGE/ WHITE/ PINK

Nº PFYCF12-COLOR (735mm)
Nº YC110-0418-01WH (BLANC/ WHITE - 660mm)
Nº YC110-0418-01BK (NOIR/ BLACK - 660mm)



**GARDE BOUE ARRIÈRE POUR PILOT 2016-25/ FACTORY 2016-25
NOIR/ BLEU/ ROUGE/ VERT/ JAUNE/ ORANGE/ BLANC/ GRIS/ ROSE**

REAR FENDER FOR PILOT 2016-25/ FACTORY 2016-25
BLACK/ BLUE/ RED/ GREEN/ YELLOW/ ORANGE/ WHITE/ GREY/ PINK

Nº YC110-14-018+COLOR



FOR 50 ONLY



PAIRE DE PROTECTIONS FOURCHE POUR YCF 50 ROUGE/ VERT/ JAUNE/ ORANGE/ BLANC
FORK GUARD FOR YCF 50 RED/ GREEN/ YELLOW/ ORANGE/ WHITE

Nº YC50-0418+COLOR



GARDE BOUE AVANT YCF NOIR/ BLEU/ BLEU YCF/ ROUGE/ VERT/ JAUNE/ ORANGE/ BLANC/ GRIS/ ROSE
 YCF FRONT FENDER BLACK/ BLUE/ YCF BLUE/ RED/ GREEN/ YELLOW/ ORANGE/ WHITE/ GREY/ PINK

N° YC110-032-10-COLOR



GARDE BOUE ARRIÈRE YCF NOIR/ ROUGE/ BLANC/ VERT/ JAUNE/ ORANGE/ BLEU/ GRIS/ ROSE
 YCF REAR FENDER BLACK/ RED/ WHITE/ GREEN/ YELLOW/ ORANGE/ BLUE/ GREY/ PINK

N° YC110-14-019-COLOR



OUIE RADIATEUR YCF DROITE NOIRE/ BLEUE/ ROUGE/ VERTE/ JAUNE/ ORANGE/ BLANCHE/ GRISE/ ROSE
 YCF RIGHT SHROUD BLACK/ BLUE/ RED/ GREEN/ YELLOW/ ORANGE/ WHITE/ GREY/ PINK

N° YC110-1406-COLOR



OUIE RADIATEUR YCF GAUCHE NOIRE/ BLEUE/ ROUGE/ VERTE/ JAUNE/ ORANGE/ BLANCHE/ GRISE/ ROSE
 YCF LEFT SHROUD BLACK/ BLUE/ RED/ GREEN/ YELLOW/ ORANGE/ WHITE/ GREY/ PINK

N° YC110-1407-COLOR



PLAQUE AVANT YCF NOIR/ BLEU/ BLEU YCF/ ROUGE/ VERT/ JAUNE/ ORANGE/ BLANC/ GRIS
YCF FRONT NUMBER PLATE BLACK/ BLUE/ YCF BLUE/ RED/ GREEN/ YELLOW/ ORANGE/ WHITE/ GREY

Nº YC110-0212-09-COLOR



PLAQUE LATÉRALE YCF DROITE NOIR/ BLEU/ ROUGE/ VERT/ JAUNE/ ORANGE/ BLANC/ GRIS
YCF RIGHT NUMBER PLATE BLACK/ BLUE/ RED/ GREEN/ YELLOW/ ORANGE/ WHITE/ GREY

Nº YC110-14-029-COLOR



PLAQUE LATÉRALE YCF GAUCHE NOIR/ BLEU/ ROUGE/ VERT/ JAUNE/ ORANGE/ BLANC/ GRIS
YCF LEFT NUMBER PLATE BLACK/ BLUE/ RED/ GREEN/ YELLOW/ ORANGE/ WHITE/ GREY

Nº YC110-14-049-COLOR



FOR 50 ONLY



KIT PLASTIQUE YCF 50 NOIR/ BLEU/ ROUGE/ VERT/ JAUNE/ ORANGE/ ROSE/ BLANC/ GRIS
YCF 50 PLASTIC KIT BLACK/ BLUE/ RED/ GREEN/ YELLOW/ ORANGE/ PINK/ WHITE/ GREY

N° KPYCF50-02-COLOR

GARDE BOUE AVANT POUR YCF 50, LITE 88 2020-25, START 88SE 2022-25, SM 2022-25 NOIR/ BLEU/ ROUGE/ VERT/ JAUNE/ ORANGE/ ROSE/ BLANC/ GRIS

FRONT FENDER FOR YCF 50, LITE 88 2020-25, START 88SE 2022-25, SM 2022-25 BLACK/ BLUE/ RED/ GREEN/ YELLOW/ ORANGE/ PINK/ WHITE/ GREY

01 N° YC50-031-01-COLOR

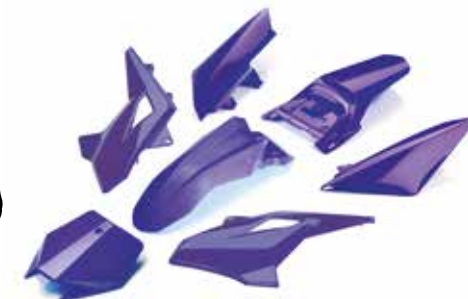

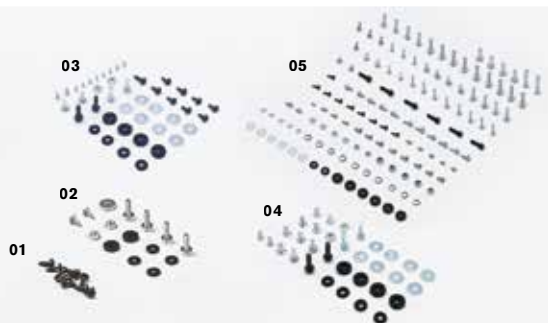

KIT VIS POUR FIXER LES PLASTIQUES SUR LA SELLE
BOLT KIT FOR FIXING THE PLASTICS TO THE SEAT

01 N° KVP

KIT VISSERIE POUR KIT PLASTIQUE (2+2 POUR RÉSERVOIR + 2 POUR SELLE SUR CADRE)
BOLT KIT FOR PLASTIC KIT (2+2 FOR FUEL TANK + 2 FOR SEAT ON FRAME)

02 N° KVP-2

KIT VISSERIE POUR PLASTIQUE START/ PILOT/ FACTORY
BOLT KIT FOR PLASTIC KIT START/ PILOT/ FACTORY

03 N° KVP-3

KIT VISSERIE POUR PLASTIQUE BIGY
BOLT KIT FOR PLASTIC KIT BIGY

04 N° KVP-4

KIT VIS COMPLET YCF
COMPLETE YCF BOLT KIT

05 N° KVP-5



PROTÈGE DISQUE AVANT NOIR/ BLEU/ ROUGE/ VERT/ JAUNE/ ORANGE/ BLANC
FRONT BRAKE PROTECTION BLACK/ BLUE/ RED/ GREEN/ YELLOW/ ORANGE/ WHITE

N° YC110-0627-01+COLOR



PASSE DURITE FREIN AVANT CNC NOIR/ BLEU/ ROUGE/ VERT/ ORANGE/ VIOLET
ALUMINUM BRAKE LINE RETAINER BLACK/ BLUE/ RED/ GREEN/ ORANGE/ PURPLE

N° YC110-0403-06+COLOR



PASSE DURITE YCF
YCF BRAKE LINE RETAINER-PLASTIC

01 N° YC110-0403-05



KIT RONDELLE CNC POUR RÉSERVOIR ET KIT PLASTIQUE, VENDU AVEC LES VIS BTR (2XM5/ 2XM6/ 1XM8)
NOIR/ BLEU/ ROUGE/ VERT/ ORANGE/ VIOLET
CNC WASHER AND BTR SCREW FOR TANK AND PLASTIC KIT (2XM5/ 2XM6/ 1XM8)
BLACK/ BLUE/ RED/ GREEN/ ORANGE/ PURPLE

N° KRV-COLOR



KIT COMPLET PHARES POUR START/ LITE/ FACTORY SP1 & SP2/ BIGY 125 & 150
LIGHT KIT FOR START/ LITE/ FACTORY SP1 & SP2/ BIGY 125 & 150

N° KL1E pour moto avec démarreur électrique/ for electric start bike
N° KL1 pour moto sans démarreur électrique/ for bike without electric start
01 N° YC110-1525-02 Bavette arrière/ tail light mud guard



PLAQUE PHARE AVANT YCF NOIRE/ BLANCHE
YCF HEADLIGHT BLACK/ WHITE

N° YC110-1523-02 - COLOR

MOTORCYCLE PARTS

PIÈCES MOTO

GUIDONS/ HANDLEBARS	84
POIGNÉES/ LEVERS	86
FOURCHES/ FORKS	88
CADRES/ FRAMES	91
SELLES/ SEATS	92
RÉSERVOIRS/ FUEL TANKS	93
FREINS/ BRAKES	94
BRAS OSCILLANTS/ SWING ARMS	102
AMORTISSEURS/ SHOCK ABSORBERS	104
ROUES/ WHEELS	105
JANTES & MOYEUX/ RIMS & HUBS	105
PNEUS/ TIRES	112
REPOSE-PIEDS & SABOTS/ FOOT PEGS & SKID PLATES	114
SÉLECTEURS/ SHIFT LEVERS	115
KITS CHÂINES/ SPROCKET KITS	116
OUTILS/ TOOLS	118
ENGI®/ ENGI®	120
PIÈCES SPÉCIALES SUPERMOTARD/ SUPERMOTO FACTORY SPECIAL PARTS	122



GUIDONS HANDLE BARS



MOUSSE GUIDON SANS BARRE
NOIRE/ BLEUE/ ROUGE/ VERTE/ JAUNE/ ORANGE/ ROSE/ BLANCHE
HANDLEBAR PAD WITHOUT CROSSBAR
BLACK/ BLUE/ RED/ GREEN/ YELLOW/ ORANGE/ PINK/ WHITE

N° YC110-01046+COLOR



MOUSSE GUIDON CAOUTCHOUC 3D
HANDLEBAR PAD WITH RUBBER COVER 3D

N° YC110-0133-01BK



FOR 50 ONLY

MOUSSE GUIDON YCF 50 SANS BARRE
NOIRE/ BLEUE/ ROUGE/ VERTE/ JAUNE/ ORANGE/ ROSE/ BLANCHE
HANDLEBAR PAD YCF 50 WITHOUT CROSSBAR
BLACK/ BLUE/ RED/ GREEN/ YELLOW/ ORANGE/ PINK/ WHITE

N° YC50-0129+COLOR



MOUSSE GUIDON NOIRE/ BLEUE/ ROUGE/ VERTE/ JAUNE/ ORANGE/ ROSE/ BLANCHE
HANDLEBAR PAD BLACK/ BLUE/ RED/ GREEN/ YELLOW/ ORANGE/ PINK/ WHITE

N° YC110-0132+COLOR



PAIRE DE PROTÈGES MAINS
HANDGUARD

N° YC110-14-070BK (NOIRE/ BLACK)
N° YC110-14-070WH (BLANCHE/ WHITE)



PAIRE DE PROTÈGES MAINS ENDURO/SUPERMOTO
(FIXATION POUR GUIDON ACIER/ALU Ø 22,2 ET 28,6)
ENDURO/SUPERMOTO HANDGUARDS
(FIXING KITS FOR STEEL/ALU Ø 22,2 AND 28,6)

N° YC110-14-071BK (NOIRE/ BLACK)
N° YC110-14-071WH (BLANCHE/ WHITE)



PROTÈGE LEVIER TYPE MOTOGP
MOTOGP STYLE LEVER PROTECTION

N° YC110-14-072BK



**GUIDON ALUMINIUM (MOUSSE COMPRISE)
NOIR/ BLEU/ ROUGE/ VERT/ ORANGE/ VIOLET**

ALUMINUM HANDLEBAR (BAR PAD INCLUDED)
BLACK/ BLUE/ RED/ GREEN/ ORANGE/ PURPLE

N° GA+COLOR



**GUIDON MID SIZE ALUMINIUM (MOUSSE COMPRISE)
NOIR/ BLEU/ ROUGE/ VERT/ ORANGE/ VIOLET**

ALUMINUM CROSS BAR (BAR PAD INCLUDED)
BLACK/ BLUE/ RED/ GREEN/ ORANGE/ PURPLE

N° GALOW+COLOR
N° GALOW-03BK (BIGY)



**GUIDON ALUMINIUM SANS BARRE (POUR YCF 50) NOIR/ BLEU/ ROUGE/ VERT/
ORANGE (MOUSSE COMPRISE)**

ALUMINUM HANDLEBAR WITHOUT CROSSBAR (FOR YCF 50) BLACK/ BLUE/ RED/ GREEN/
ORANGE (BAR PAD INCLUDED)

01 N° GASB50+COLOR

**GUIDON ALUMINIUM SANS BARRE BLEU/ NOIR/ ROUGE/ ORANGE/ VERT/ VIOLET
(MOUSSE COMPRISE)**

ALUMINUM HANDLEBAR WITHOUT CROSSBAR BLUE/ BLACK/ RED/ ORANGE/ GREEN/
PURPLE (BAR PAD INCLUDED)

02 N° GASB+COLOR



GUIDON ACIER (POUR YCF 50)

STEEL HANDLEBAR (FOR YCF 50)

GUIDON CHROMOLLY 22,2mm

CHROMOLY HANDLEBAR 22,2mm

- 01 N° YC50-0101-02 (YCF 50)
- 02 N° YC110-0101-34-BK (LITE/ START/ PILOT)
- 03 N° YC110-0101-12 (BAS/ LOW: 665mm)
- 04 N° YC110-0101-1601-BK (BIGY: 780mm)
- 05 N° YC110-0101-36-BK (BAS/ LOW: 760mm) SM 2024-25



**GUIDON ALUMINIUM RENFORCÉ 28.6 mm
ALUMINUM HANDLEBAR 28.6 mm**

N° GA-02BK (FACTORY 760mm)
N° GALOW-04BK (BIGY 780mm)



POIGNÉES HANDLES



FOR 50 ONLY



01

02

FACTORY
SPECIAL PARTS
YCF RACING

**LEVIER DE FREIN AVANT OU ARRIÈRE PLIABLE POUR YCF 50 2020-25
NOIR/ BLEU/ ROUGE/ VERT/ ORANGE**

FOLDABLE FRONT OR REAR BRAKE LEVER FOR YCF 50 2020-25
BLACK/ BLUE/ RED/ GREEN/ ORANGE

01 № LFG50-1-COLOR (ARRIÈRE/ REAR)
02 № LFD50-1-COLOR (AVANT/ FRONT)



FACTORY
SPECIAL PARTS
YCF RACING

LEVIER D'EMBRAYAGE AVEC COCOTTE CNC NOIR/ BLEU/ ROUGE/ VERT
CLUTCH LEVER WITH CNC BRACKET BLACK/ BLUE/ RED/ GREEN

№ YC110-0103-06+COLOR

FACTORY
SPECIAL PARTS
YCF RACING



01

02

**LEVIER DE FREIN OU D'EMBRAYAGE PLIABLE NOIR/ BLEU/ ROUGE/ VERT/ ORANGE/
VIOLET VENDU AVEC LA COCOTTE**

FOLDABLE BRAKE OR CLUTCH LEVER BLACK/ BLUE/ RED/ GREEN/ ORANGE/ PURPLE
SOLD WITH BRACKET

01 № LFP21-COLOR (FREIN/BRAKE)
02 № LEP21-COLOR (EMBRAYAGE/ CLUTCH)



01

02

**LEVIER FREIN OU EMBRAYAGE REPLIABLE
VENDU AVEC LA COCOTTE**

FOLDABLE BRAKE OR CLUTCH LEVER
SOLD WITH BRACKET

01 № LEPLIABLE (EMBRAYAGE/ CLUTCH)
02 № LFPLIABLE (FREIN/ BRAKE)



01

03

02

**POIGNÉE DE GAZ À TIRAGE RAPIDE YCF (VENDU AVEC
LES 2 POIGNÉES)**

YCF QUICK-ACTION THROTTLE TUBE (INCLUDE GRIP)

01 № YC110-0138-03

POIGNÉE DE GAZ AVEC RÉGLAGE (VIS DE BRIDAGE)

THROTTLE TUBE WITH ADJUSTMENT SCREW (POWER
CONTROL)

02 № YC110-0138-04 (Vendu avec les 2 poignées)

VIS M5X50 POUR RÉGLAGE DE LA POIGNÉE DE GAZ

SCREW FOR THROTTLE ADJUSTMENT, SIZE M5X50

03 № YC110-01022-06





LEVIER FREIN PLIABLE
FOLDABLE BRAKE LEVER

N° YC110-0517-01



LEVIER D'EMBRAYAGE + COCOTTE AVEC MOLETTE RAPIDE (2020-25)

CLUTCH LEVER + BRACKET WITH FAST WRENCH ADJUSTER (2020-25)

N° YC110-0135-02



COCOTTE D'EMBRAYAGE
CLUTCH BRACKET

01 N° YC110-0134-04 (2020-25)

LEVIERS FREIN & EMBRAYAGE
BRAKE & CLUTCH LEVERS

03 N° YC110-0103-07 (EMBR./ CLUTCH)
(PILOT/ SM/ FACTORY/ BIGY 2020-25)
04 N° YC110-0501-014 (FREIN/ BRAKE) (2005-17)
05 N° YC110-0103-03 (EMBR./ CLUTCH) (2005-17)

CAOUTCHOUC DE LEVIER FREIN & EMBRAYAGE
RUBBER BRAKE & CLUTCH LEVERS

06 N° YC110-0502-01 (FREIN/ BRAKE)
07 N° YC110-0103-10 (EMBRAYAGE/ CLUTCH)

LEVIER FREIN RÉGLABLE POUR KIT FREIN 4 PISTONS
ADJUSTABLE BRAKE LEVER FOR 4 PISTONS BRAKE KIT

02 N° YC110-0501-012

SPECIAL PARTS
YCF RACING



POIGNÉES CAOUTCHOUC YCF (X2)
NOIRE/ BLEUE/ ROUGE/ VERTE/ JAUNE/ ORANGE/ ROSE/ BLANCHE/ GRISE

YCF RUBBER GRIPS (X2) BLACK/ BLUE/ RED/ GREEN/ YELLOW/ ORANGE/ PINK/ WHITE/ GREY

N° PPC011-COLOR



DONUTS (X2) NOIR/ ROUGE/ JAUNE/ ORANGE/ BLEU

GRIP DONUTS (X2) BLACK/ RED/ YELLOW/ ORANGE/ BLUE

N° DONUTZ-02-COLOR



LEVIER FREIN COMPLET AVEC COCOTTE POUR YCF 50
BRAKE LEVER COMPLETE WITH BRACKET FOR YCF 50

01 N° YC50-0501 (AVANT/ FRONT) (YCF 50 2012-19)
02 N° YC50-01031 (ARRIÈRE/ REAR) (YCF 50 2012-19)
03 N° YC50-0503-05 (FREIN AVANT/ FRONT BRAKE)
(YCF 50 2020-25)
04 N° YC50-0503-06 (FREIN ARRIÈRE/ REAR BRAKE)
(YCF 50 2020-25)



CÂBLE EMBRAYAGE
CLUTCH CABLE

01 N° YC110-0107 (SM125 2021-25/ PILOT 125 2022-25/
GP 125/ GP 187)
01 N° YC110-0108 (SM 155 2020-25/ GP 187)
01 N° YC110-0109-22 (SP2/ SP3/ BIGY 125 MX 2021-25/
BIGY 150 MX/ BIGY F150E/ BIGY F190 MX)
01 N° 14020500 (PILOT 150E/ SUNDAY 147)
02 N° YC110-0109-11 (LITE 125/ START 125)



CÂBLE DE GAZ
THROTTLE CABLE

N° YC110-0106 (LITE 88/ LITE 125/ START 88SE/ START
125SE/ START 125/ PILOT 125/ PILOT 150E/ SP2/ SP3/
SM 125/ SM 155/ SUNDAY 147 2018-20/ SUNDAY 187
2018-20/ GP 107A/ GP 124/ GP 157/ GP 187)
N° YC50-0106-14 (FOR 50 ONLY)
N° YC110-0106-15 (SM 190/ BIGY/ SUNDAY 147 2021-22/
SUNDAY 187 2021-22)

FOURCHES FORKS



KIT RÉFÉCTION FOURCHE TAILLE 33/46/11 : 1 JOINT SPY/ 1 CACHE POUSSIÈRE/ 1 BAGUE INF/ 1 BAGUE SUP

FORK REPAIR KIT SIZE 33/46/11 INCLUDING: 1 FORK OIL SEAL/ 1 DUST COVER/ 1 LOWER RING/ 1 UPPER RING

N° YC110-0470

JOINT SPY FOURCHE

FORK OIL SEAL

01 N° YC50-0415 (POUR/ FOR 50 - 25X25X10)

01 N° YC110-0440 (33*46*11) START/ PILOT/ FACTORY/ BIGY



TÉ FOURCHE COMPLET 170MM SP3 48/48 (AVEC PONTETS GUIDON 28,6mm) (NOIR/ BLEU/ ROUGE/ VERT/ ORANGE/ VIOLET)

TRIPLE CLAMP SET 48/48 170MM SP3
(WITH BAR MOUNTS 28,6mm)
(BLACK/ BLUE/ RED/ GREEN/ ORANGE/ PURPLE)

01 N° YC110-0225-05+COLOR



JEU TUBE FOURCHE UPSD RÉGLABLE

ADJUSTABLE FORK

N° YC110-0400-10 (735mm)

N° YC110-0400-47 (775mm)

N° YC110-0400-35 (800mm)



JEU TUBE FOURCHE UPSD NON RÉGLABLE

UPSD FORK

N° YC110-0400-43 (600mm)

N° YC110-0400-41 (660mm)

N° YC110-0400-40 (735mm)

N° YC110-0400-33 (785mm)

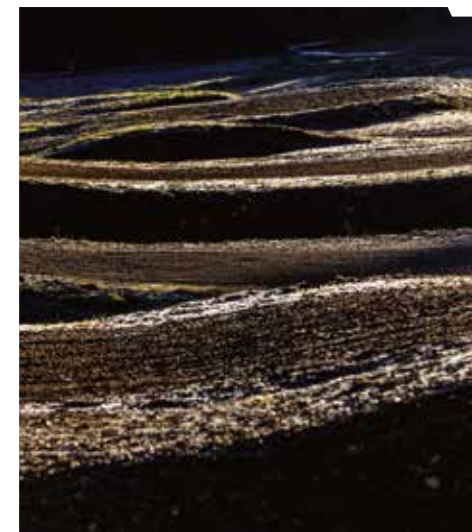



TÉ FOURCHE COMPLET 160mm 45/48 OU 48/48 (NOIR/ BLEU/ ROUGE/ VERT/ ORANGE/ VIOLET)
TRIPLE CLAMP SET 160mm 45/48 OR 48/48 (BLACK/ BLUE/ RED/ GREEN/ ORANGE/ PURPLE)

N° YC110-02-053+COLOR (45/48)
N° YC110-02-049+COLOR (48/48)



JEU DE PONTETS GUIDON YCF 2012-2019
BAR MOUNTS FOR YCF 2012-2019

01 N° YC110-0203-05 (LITE/ START/ PILOT/ SM/ BIGY MX) Ø 22,2
02 N° YC110-0203-15 (SP3 2016-19/ BIGY 190 DAYTONA 2017-19) Ø 28,6
03 N° YC110-0222-01 CALE POUR PONTET GUIDON ÉPAISSEUR 20mm (VENDU PAR PAIRE) (NON RÉGLABLE/ NOT ADJUSTABLE)
03 N° YC110-0222-02 CALE POUR PONTET GUIDON ÉPAISSEUR 20mm (VENDU PAR PAIRE) (RÉGLABLE/ ADJUSTABLE)



JEU DE PONTETS GUIDON YCF 2020-25
BAR MOUNT FOR YCF 2020-25

04 N° YC110-0203-038 (FACTORY SP3/ BIGY 190 DAYTONA) Ø 28,6
05 N° YC110-0203-035 (50/ LITE/ START/ PILOT/ SP2/ BIGY MX) Ø 22,2
06 N° YC110-0222-03 CALE POUR PONTETS GUIDON (VENDU PAR PAIRE)
07 N° GB70-M10x50x1.5W VIS DE PONTET



ÉCROU POUR COLONNE DE DIRECTION
STEERING STEM NUT

01 № YC110-02-09 (NOTCHED/ CRANTÉ)
02 № YC110-02-11 (SUPÉRIEUR/ UPPER)



JOINT POUR COLONNE DE DIRECTION ADAPTABLE
SUR START/ PILOT/ FACTORY/ SM/ BIGY
SEAL FOR STEERING STEM ADAPTABLE ON START/ PILOT/
FACTORY/ SM/ BIGY

№ YC110-02-20



JEU DE ROULEMENT COLONNE DIRECTION
TAPER ROLLER BEARING FOR STEERING STEM

№ KRDIRIRECTION41-2, YCF50 2012-19 – START 88 2008-19 – LITE88/125 2016-19
(INFÉRIEUR Ø EXT 41 - INT 24mm/ SUPÉRIEUR Ø EXT 41 - INT 22,5mm)
№ KRDIRIRECTION46, ALL START 125 – PILOT – FACTORY – BIGY and 50A-E 2020-25 – START 88SE 2020-25
LITE 88-125 2020-25 (INFÉRIEUR Ø EXT 46 - INT 23,5mm/ SUPÉRIEUR Ø EXT 46 - INT 22mm)



ÉCROU POUR COLONNE DE DIRECTION NOIR/ BLEU/ ROUGE/ VERT/ ORANGE/ VIOLET
STEERING STEM NUT BLACK/ BLUE/ RED/ GREEN/ ORANGE/ PURPLE

№ ECD-COLOR



CADRES FRAMES



BÉQUILLE SIDE STAND

- 01 N° YC50-210-01 (50)
- 01 N° YC110-0904-01 (RÉGLABLE 250mm to 350mm)
- 01 N° YC110-0904-05 (BIGY)

RESSORT DE BÉQUILLE SIDE STAND SPRING

- 02 N° YC110-19-01

VIS ET ÉCROU BÉQUILLE SIDE STAND SCREW & NUT

- 03 N° GB6170-M10-G (ÉCROU/ NUT)
- 04 N° FB02-M10x1,5x30I (VIS/ SCREW)

KIT VIS RENFORCÉE POUR MOTEUR ENGINE REINFORCED SCREW SET

- 05 N° KITVIS8 (Ø 8)
- 05 N° KITVIS10 (Ø 10)

PATTE DE CADRE FRAME STEEL PADS

- N° YC110-16-061BK (START F125)
- N° YC110-16-067BK (PILOT 2013)
- N° YC110-1622-02BK (PILOT 2014-2025)
- N° YC110-1622-03 (BIGY)



**CADRE RENFORCÉ 88 POUR BRAS MONO
(BOUCLE ARRIÈRE INCLUSE)**
88 REINFORCED FRAME FOR MONO SWING ARM
(REAR SUBFRAME INCLUDED)

N° YC88-161-0301-BK (START SE88)



BOUCLE ARRIÈRE 88
88 REAR SUBFRAME

N° YC88-16-020 (START F88S)
N° YC88-16-022-BK (START F88SE)



**CADRE RENFORCÉ LITE POUR BRAS CANTILEVER
(BOUCLE ARRIÈRE INCLUSE)**
LITE YCF REINFORCED FRAME FOR CANTILEVER SWING
ARM (REAR SUBFRAME INCLUDED)

N° YC110-161-0301-BK (LITE88)
N° YC110-161-0401-BK (LITE 125/ 150)



BOUCLE ARRIÈRE LITE
LITE REAR SUBFRAME

N° YC110-1614-23-BK (LITE F88)
N° YC110-1614-24-BK (LITE F125/ F150)

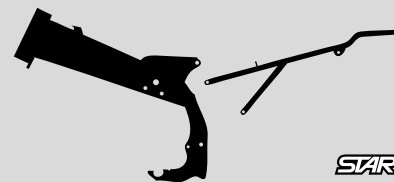

**CADRE START POUR BRAS MONO
ET AMORTISSEUR 270mm (BOUCLE AR. INCLUSE)**
START FRAME FOR MONO SWING ARM AND SHOCK
ABSORBER 270mm (REAR SUBFRAME INCL.)

N° YC110-166-0201-BK (START 125S)



BOUCLE ARRIÈRE START 125
START 125 REAR SUBFRAME PART

N° YC110-16-070BK
N° YC110-1614-28-BK (START 125SE)



**CADRE COMPLET PILOT 125 & 150 2018-25
(AXE BRAS Ø 15) (BOUCLE ARRIÈRE INCLUSE)**
2018-25 PILOT 125 & 150 COMPLETE FRAME (ARM AXLE Ø 15)
(REAR SUBFRAME INCLUDED)

N° YC110-1621-0301-BK (NOIR/BLACK) (axle 15)



BOUCLE ARRIÈRE PILOT
PILOT REAR SUBFRAME

N° YC110-1614-26-BK (2016-25)



CADRE YCF 2019-2025 FACTORY (BOUCLE AR. INCLUSE)
2019-25 FACTORY YCF FRAME (REAR SUBFRAME INCL.)

N° YC110-1621-0801-BK (CADRE 22°)



BOUCLE ARRIÈRE FACTORY
FACTORY REAR SUBFRAME

N° YC110-1614-15-BK (2016-25 ACIER/ STEEL)
N° YC110-1614-18 (2016-25 ALUMINIUM)



**CADRE YCF 2018-25 BIGY (AXE BRAS Ø 15) (BOUCLE
ARRIÈRE INCLUSE)**
2018-25 BIGY YCF FRAME (ARM AXLE Ø 15) (REAR SUBFRAME
INCLUDED)

N° YC110-1621-0201-BK (COMPLET)



BOUCLE ARRIÈRE BIGY
BIGY REAR SUBFRAME

N° YC110-1614-08-BK (ACIER/ STEEL)
N° YC110-1614-09-BK (190ZE/ F150E 2022-25)

SELLES SEATS

FACTORY
SPECIAL PARTS
YCF RACING



SELLE COMPLÈTE ANTI DÉRAPANTE RENFORCÉE BLEUE/ ROUGE/ VERTE/ JAUNE/ ORANGE
COMPLETE NON-SLIP REINFORCED SEAT BLUE/ RED/ GREEN/ YELLOW/ ORANGE

N° YC110-1401-12+COLOR (BIGY)

FACTORY
SPECIAL PARTS
YCF RACING



SELLE COMPLÈTE ANTI DÉRAPANTE RENFORCÉE BLEUE/ ROUGE/ VERTE/ JAUNE/ ORANGE
COMPLETE NON-SLIP REINFORCED SEAT BLUE/ RED/ GREEN/ YELLOW/ ORANGE

N° YC110-1401-08+COLOR (LITE 2016-25, START 2009-25, PILOT 125 2013-14)
N° YC110-1401-07+COLOR (PILOT 125 2015-25, PILOT 150, FACTORY, SM 150)



SELLE YCF POUR BIGY
YCF SEAT FOR BIGY

N° YC110-1401-11

FACTORY
SPECIAL PARTS
YCF RACING



SELLE YCF LONGUE PILOT 125 2015-25/ PILOT 150 2013-25/ FACTORY 2012-25/ SM 150 2013-25/ SM 190 2023-2025
YCF LONG SEAT PILOT 125 2015-25/ PILOT 150 2013-25/ FACTORY 2012-25/ SM 150 2013-25/ SM 190 2023-2025

N° YC110-1401-17



FOR 50 ONLY

01

02



SELLE YCF 50
YCF 50 SEAT

01 N° YC50-1401-05
02 N° YC50-1401-03 (HAUTE/ HIGH + 4 cm)

**NEW
2025**



SELLE LITE 2016-25/ START 2009-25/ PILOT 125 2013-14
SEAT LITE 2016-25/ START 2009-25/ PILOT 125 2013-14

N° YC110-1401-21



SELLE BASSE YCF POUR LITE 2016-25/ START 2009-25/ PILOT 125 2013-14
YCF LOW SEAT FOR LITE 2016-25/ START 2009-25/ PILOT 125 2013-14

N° YC110-14013



➤ RÉSERVOIRS FUEL TANKS



RÉSERVOIR ET COUVRE RÉSERVOIR YCF POUR BIGY
YCF FUEL TANK AND TANK COVER FOR BIGY

01 N° YC110-0701-04
02 N° YC110-0719-01



RÉSERVOIR YCF (ADAPTABLE SUR TOUTES LES ANCIENNES YCF ET SUR LES MINIS AVEC RÉSERVOIR TYPE CRF 50)
YCF FUEL TANK (CAN BE ADAPTED TO ALL PREVIOUS YCF AND TO MINI-BIKES WITH A TYPE CRF 50 FUEL TANK)

N° YC110-0701-01



RÉSERVOIR POUR YCF 50
FUEL TANK FOR YCF 50

N° YC50-07012



BOUCHON RÉSERVOIR ALUMINIUM YCF NOIR/ BLEU ROUGE/ VERT/ ORANGE/ VIOLET
YCF ALUMINUM GAS CAP BLACK/ BLUE / RED/ GREEN ORANGE/ PURPLE

N° BOUCHONALU-COLOR



VALVE PRISE AIR NOIRE/ BLEUE/ ROUGE/ VERTE/ ORANGE/ VIOLET
FUEL VENT VALVE BLACK/ BLUE/ RED/ GREEN/ ORANGE/ PURPLE

N° YC125-0704-COLOR



DURITE ESSENCE NOIRE/ BLEU/ ROUGE/ VERT/ JAUNE/ ORANGE/ ROSE

FUEL LINE BLACK/ BLUE/ RED/ GREEN/ YELLOW/ ORANGE/ PINK

N° DC-COLOR



ROBINET ESSENCE
FUEL PETCOCK

N° YC110-0703 (1 EXIT FOR YCF/ 1 SORTIE POUR YCF)



BOUCHON ET JOINT RÉSERVOIR PLASTIQUE
GAS CAP AND SEAL

01 N° YC110-0702-01 (YCF ORIGINAL DESIGN)
02 N° YC110-0720-02

FREINS BRAKES



PATTE DE FREIN CNC POUR ÉTRIER RADIAL
CNC ALUMINUM BRACKET FOR RADIAL BRAKE CALIPER

01 N° YC110-0510-06-SI (AV./FR. FOR DISK 220 MM)
01 N° YC110-0510-07-SI (AV./FR. FOR DISK 240 MM)
02 N° YC110-1210-06-SI (ARR./ REAR)

**RESSORT ANTI VIBRATION
POUR ÉTRIER RADIAL ARRIÈRE**
REAR SPRING ANTI VIBRATION
FOR REAR CNC RADIAL BRAKE

03 N° YC110-1256-02

**RESSORT PLAQUETTE DE FREIN
POUR ÉTRIER RADIAL AVANT**
BRAKE PADS SPRING FOR FRONT CNC RADIAL BRAKE

04 N° YC110-0556-02

AXE DE PLAQUETTE DE FREIN POUR ÉTRIER RADIAL
BRAKE PADS AXLE FOR CNC RADIAL BRAKE

05 N° YC110-0555-02 (AVANT/ FRONT)
06 N° YC110-1255-02 (ARRIÈRE/ REAR)



KIT FREIN AVANT RADIAL - KIT FREIN ARRIÈRE RADIAL
RADIAL FRONT BRAKE KIT - RADIAL REAR BRAKE ASSEMBLY

01 N° YC110-05012-09BK (AVANT/ FRONT)
02 YC110-12012-08BK (ARRIÈRE/ REAR)



KIT FREIN ARRIÈRE AU POUCE
THUMB BRAKE

N° YC110-1212-13



MAÎTRE CYLINDRE FREIN AVANT SUPERMOTARD
SUPERMOTARD FRONT BRAKE MASTER CYLINDER

N° YC110-0507-01



LEVIER FREIN SEUL POUR MAÎTRE CYLINDRE FREIN AVANT SM
SM BRAKE LEVER FOR FRONT BRAKE MASTER CYLINDER

N° YC110-0503-02



ÉTRIER FREIN CNC RADIAL FACTORY
FACTORY BRAKE CALIPER RADIAL CNC

01 N° YC110-1201-06-BK (ARRIÈRE/ REAR)
02 N° YC110-0502-06-BK (AVANT/ FRONT)



KIT FREIN AVANT FACTORY (LEVIER RÉGLABLE) 2016-25
 FACTORY FRONT BRAKE KIT (ADJUSTABLE LEVER) 2016-25

N° YC110-0501-3101 (SP2/ SP3/ BIGY)



KIT FREIN ARRIÈRE FACTORY 2016-2025
 FACTORY REAR BRAKE ASSEMBLY 2016-2025

N° YC110-12012-2601 (SP2/ SP3)
 N° YC110-12012-2801 (BIGY FACTORY)



KIT FREIN ARRIÈRE HYDRAULIQUE YCF 50 2020-25 (ADAPTABLE SUR LES YCF 50 2012-2019)

HYDRAULIC REAR BRAKE KIT YCF 50 2020-25 (CAN FIT ON YCF 50 2012-2019)

N° YC50-1214-03



KIT FREIN AVANT HYDRAULIQUE YCF 50 2020-25 (ADAPTABLE SUR LES YCF 50 2012-2019)

HYDRAULIC FRONT BRAKE KIT YCF 50 2020-25 (can fit on YCF 50 2012-2019)

N° YC50-0511-03





ÉTRIER FREIN AVANT
FRONT BRAKE CALIPER

- 01 N° YC110-0501-0205 (DOUBLE PISTON) (START 125-BIGY 125-150 MX)
- 02 N° YC50-0502 (YCF 50)
- 06 N° YC110-0501-0207 (SP3 2016-25 - BIGY FACTORY 150-190)

MAÎTRE CYLINDRE AVANT
FRONT BRAKE MASTER CYLINDER

- 03 N° YC110-0501-0103 (FREINAGE À GAUCHE)
- 03 N° YC110-0501-0104-02 (DOUBLE PISTON) (LITE/ START)
- 05 N° YC110-0501-0101 (4 PISTONS)
- 04 N° YC110-0501-0104-03 (PILOT/ FACTORY/ BIGY 2016-25)

DURITE FREIN AVANT
FRONT BRAKE HOSE

- 05 N° YC110-0501-0325
(FILETAGE AU MAÎTRE CYLINDRE) (LITE/START)
- 05 N° YC110-0501-0327
(BANJO AU MAÎTRE CYLINDRE) (SP2/ SP3/ BIGY)



KIT FREIN COMPLET AVANT AVEC ÉTRIER DOUBLE PISTON
COMPLETE FRONT BRAKE KIT WITH DOUBLE PISTON CALIPER

- N° YC110-0501-1801 (LITE/ START 125)
- N° YC110-0501-3301 (BIGY/ PILOT/ SM F150)



KIT FREIN AVANT COMPLET START F88
COMPLETE FRONT BRAKE KIT START F88

- N° YC110-0501-2001 (START 88 2020-25)





ÉTRIER FREIN ARRIÈRE
REAR BRAKE CALIPER

- 01 N° YC110-1201-0401 (1 PISTON) (LITE/ START/ PILOT/ BIGY 125-150 MX)
- 06 N° YC110-1201-07 (SP3 2016-25/ BIGY FACTORY 150-190)

MAÎTRE CYLINDRE FREIN ARRIÈRE
REAR BRAKE MASTER CYLINDER

- 02 N° YC110-1201021 (Ø 8/ DIST. 40mm) (START)
- N° YC110-1201023 (Ø 10/ DIST. 40mm) (SM 190)
- N° YC110-1201026 (Ø 10/ LITE)
- N° YC50-1201 (YCF50) pour frein à câble / for brake cable
- 06 N° YC110-1201024 (PILOT/ FACTORY / BIGY)

JEU DE CAOUTCHOUCS ÉTRIER FREIN ARRIÈRE
SET OF REAR BRAKE CALIPER RUBBER

- 03 N° YC110-120110

DURITE FREIN ARRIÈRE Ø 10 ÉTRIER
REAR BRAKE HOSE CONNECTION Ø 10 CALIPER

- 04 N° YC110-1201061 (Ø 8 MASTER CYLINDER) 370mm (START)
- 04 N° YC110-1201062 (Ø 8 MASTER CYLINDER) 465mm (PILOT)
- 04 N° YC110-1203-04 (Ø 10/ MASTER CYLINDER) 425 (LITE)
- 04 N° YC110-1201052 (Ø 10/ MASTER CYLINDER) 465mm (SP2)
- 04 N° YC110-1201063 (Ø 10/ MASTER CYLINDER) 515mm (SP3/ BIGY)



KIT FREIN COMPLET ARRIÈRE 1 PISTON
COMPLETE REAR BRAKE ASSEMBLY

- N° YC110-12012-0601 (START)
- N° YC110-12012-3101 (LITE)
- N° YC110-12012-2701 (BIGY)
- N° YC110-12013-0301 (360 mm START 88SE 2020-25)
- N° YC110-12012-2401 (PILOT/ SM F150)



MAÎTRE CYLINDRE AVEC BOCAL
MASTER CYLINDER WITH RESERVOIR

- N° YC110-120102





FACTORY

**PÉDALE DE FREIN PILOT/FACTORY/BIGY
AVEC ROULEMENT**

PILOT/FACTORY/BIGY BRAKE PEDAL WITH BEARING

N° YC110-219-03



FACTORY

PÉDALE DE FREIN PILOT/FACTORY/BIGY AVEC ROULEMENT

PILOT/FACTORY/BIGY BRAKE PEDAL WITH BEARING

N° YC110-219-03-BK



START

PÉDALE FREIN ALUMINIUM POUR 88/125 START

ALUMINIUM BRAKE PEDAL FOR 88/125 START

N° YC110-218



START

PÉDALE FREIN ACIER POUR START 88/125

STEEL BRAKE PEDAL FOR 88/125 START

N° YC110-211



FOR 50 ONLY



KIT PÉDALE FREIN AU PIED POUR YCF 50 2012-25

BRAKE PEDAL KIT FOR YCF 50 2012-25

N° YC50-1219



**PÉDALE DE FREIN ALUMINIUM HAUT DE GAMME
2010-2011-CLASSIC 2012**

ALUMINIUM BRAKE PEDAL HIGH-RANGE 2010-2011-
CLASSIC 2012

N° YC110-215



**EMBOUT PÉDALE FREIN ALUMINIUM NOIR/ BLEU/
ROUGE/ VERT/ ORANGE/ VIOLET**

COLOR REAR BRAKE LEVER TIPS BLACK/ BLUE/ RED/
GREEN/ ORANGE/ PURPLE

N° YC110-1223-02-COLOR



PÉDALE DE FREIN ACIER

STEEL BRAKE PEDAL

N° YC110-217-02 (PILOT/ SM150 2013-25)



**CHAPE MAÎTRE CYLINDRE FREIN ARRIÈRE CNC
NOIR/ BLEU/ ROUGE/ VERT/ ORANGE/ VIOLET**

CNC REAR BRAKE CLEVIS BLACK/ BLUE/ RED/ GREEN/
ORANGE/ PURPLE

N° EMC-COLOR

N° EMC01-COLOR (PILOT/ FACTORY/ BIGY 2016-25)



**PROTECTION MAÎTRE CYLINDRE FREIN ARRIÈRE
POUR LITE/ START 2007-25/ PILOT/ FACTORY 2007-15**

REAR BRAKE MASTER CYLINDER GUARD
FOR LITE/ START 2007-25/ PILOT/ FACTORY 2007-15

N° YC110-1224



EMBOUT PÉDALE FREIN

REAR BRAKE LEVER TIPS

01 N° YC110-1223-01 (ACIER/ STEEL)

02 N° YC110-1223-02 (ALUMINIUM)

**CÂBLE DE PÉDALE DE FREIN ARRIÈRE AVEC GAINÉ
(POUR ÉVITER DE TORDRE LA PÉDALE DE FREIN)**

REAR BRAKE PEDAL CABLE WITH SHEATH
(TO AVOID BRAKE PEDAL TWISTING)

03 N° YC110-1260-01

RESSORT PÉDALE FREIN

BRAKE PEDAL SPRING

04 N° YC110-21-01 (ACIER/ STEEL)

04 N° YC110-21-06 (ALUMINIUM FACTORY)

FACTORY 190 SP3

YCF FACTORY DAYTONA 190 ANIMA
RIDER : COISY BENJAMIN
TEAM : YCF FRANCE





DISQUE DE FREIN ENTRAXE 102,5mm Ø INT. 76mm
BRAKE DISC CENTER TO CENTER DISTANCE 102,5mm
INNER Ø 76mm

N° YC110-1115-06 (ARRIÈRE/ REAR 200mm PERCÉ EN 10mm)
N° YC110-1115-07 (AVANT/ FRONT 220mm PERCÉ EN 10mm)



KIT VIS INOX POUR DISQUE DE FREIN
INOX BOLT KIT FOR BRAKE DISC

N° KVD (DIAM 8)
N° KVD-01 (DIAM 10)



DISQUE FREIN AVANT FLOTTANT 220mm
SEMI FLOATING BRAKE ROTOR 220mm

N° YC110-0613-01-BK



DISQUE DE FREIN AVANT 240mm AVEC PATTE DE DÉPORT
240mm FRONT BRAKE DISC WITH LEG OFFSET

N° KS2



DISQUE DE FREIN AVANT FLOTTANT 240mm AVEC PATTES DE DÉPORT

240mm SEMI FLOATING BRAKE ROTOR WITH CALIPER MOUNTING BRACKETS KIT

N° KS2-1



JEU DE PLAQUETTES FREIN AV. & AR. POUR YCF 50
SET OF BRAKE PADS FRONT & REAR FOR YCF 50

01 N° YC50-0506 (2012-2019)
13 N° YC50-0506-02 (YCF 50 2020-25 HYDRAULIQUE)

JEU DE PLAQUETTES FREIN ARRIÈRE
REAR BRAKE PADS

02 N° 14030213/4N (YCF 2005)
09 N° YC110-1204-02 (SP 2016-25/ BIGY/ FACTORY 2017-25)

JEU DE PLAQUETTES FREIN AR. 1 PISTON YCF
REAR BRAKE PADS SINGLE 1 PISTON YCF

03 N° YC110-120104 (START 2012-25/ LITE 2016-25)

JEU DE PLAQUETTES FREIN AVANT YCF 2005
FRONT BRAKE PADS YCF 2005

04 N° 14010114/5

JEU DE PLAQUETTES FREIN AVANT/ARRIÈRE POUR ÉTRIER 4 PISTONS POUR YCF 2007 ET 88 2009-11
BRAKE PADS FRONT/REAR FOR 4 PISTONS CALIPER FOR YCF 2007 AND 88 2009-11

05 N° YC110-0501-0401

JEU DE PLAQUETTES FREIN AVANT
FRONT BRAKE PADS

06 N° YC110-0501-0406
10 N° YC110-0501-0416 (SP 2016-25/ BIGY/ FACTORY 2017-25)

JEU DE PLAQUETTES SIMPLE PISTON POUR YCF 2006
BRAKE PADS SINGLE PISTON FOR YCF 2006

07 N° YC110-0501-0402

JEU DE PLAQUETTES FREIN AVANT YCF 2008-25
FRONT BRAKE PADS YCF 2008-25

08 N° YC110-0501-0403

VIS PLAQUETTE FREIN AVANT OU ARRIÈRE
FRONT OR REAR BRAKE PADS SCREW

14 N° YC110-1255 (ARRIÈRE/ REAR) LITE/ START/ PILOT/ BIGY AVANT/BEFORE 2021
15 N° YC110-0555 (AVANT/ FRONT) START 2008-19/PILOT 2013-19/ FACTORY 2013-15/ SM 2010-19/ BIGY MX 2017-19
16 N° YC110-0555-01 (AVANT/FRONT-ARRIÈRE/REAR) SP A PARTIR - FROM 2016/ BIGY FACTORY
17 N° YC110-1255-04 (ARRIÈRE/REAR) LITE/ START/ PILOT/ BIGY MX 2021

JEU DE PLAQUETTES FREIN RADIAL AV. & AR.
SET OF RADIAL BRAKE PADS FRONT & REAR

11 N° YC110-0506-01 (AVANT/ FRONT)
12 N° YC110-1204-01 (ARRIÈRE/ REAR)



CAPOT MAÎTRE CYLINDRE FREIN AVANT CNC
NOIR/ BLEU/ ROUGE/ VERT/ ORANGE/ VIOLET

FRONT BRAKE RESERVOIR COVER BLACK/ BLUE/ RED/ GREEN/ ORANGE/ PURPLE

N° FBRC-COLOR (ALL YCF MODELS EXCEPT PILOT/ FACTORY 2016-2025)
 N° FBRC01-COLOR (PILOT/ FACTORY/ BIGY 2016-25)



CAPOT MAÎTRE CYLINDRE FREIN ARRIÈRE CNC
NOIR/ BLEU/ ROUGE/ VERT/ ORANGE/ VIOLET

REAR BRAKE RESERVOIR COVER BLACK/ BLUE/ RED/ GREEN/ ORANGE/ PURPLE

N° RBRC-COLOR (ALL YCF MODELS EXCEPT PILOT/ FACTORY 2016-2025)
 N° RBRC01-COLOR (PILOT/ FACTORY/ BIGY 2016-25)

BRAS OSCILLANTS SWING ARMS



DIABOLO CNC NOIR/ BLEU/ ROUGE / VERT/ ORANGE
CNC REAR SPOOL BLACK/ BLUE/ RED/ GREEN/ ORANGE

N° KRS-COLOR



BRAS OSCILLANT MONO ALU RENFORCÉ
ALUMINUM REINFORCED MONO SWING ARM

N° YC110-10015-0101 (420mm POUR/ FOR SP2 2014-2025/ SP3 2014-18)
N° YC110-1001-2102 (460mm POUR/ FOR SP3 2019-25)
N° YC110-1001-1603 (460mm, AXE 15 POUR/ FOR BIGY 2018-25)
N° YC110-1001-23 (490mm, AXE 15 POUR/ FOR BIGY SM 17/17 ou BIGY MX 16/19)



BRAS OSCILLANT MONO CHROMOLY START
START MONO CHROMOLY SWING ARM

N° YC110-1001-0701 (350mm) (START 88)
N° YC110-10014-01 (390mm) (START 125)



BRAS OSCILLANT MONO CHROMOLY
CHROMOLY MONO SWING ARM

N° YC110-1001-1701 (420mm, AXE 15 POUR/ FOR PILOT 2018-25)
N° YC110-1001-1501 (460mm, AXE 15 POUR/ FOR BIGY 2018-25)



BRAS OSCILLANT CANTILEVER LITE
LITE CANTILEVER SWING ARM

N° YC110-1001-1201



PROTÈGE DISQUE ARRIÈRE RENFORCÉ NYLON
REINFORCED NYLON REAR DISC GUARD

N° YC110-1024-04



PROTÈGE DISQUE ARRIÈRE
REAR DISC GUARD

N° YC110-1010



VIS ET ÉCROU TENDEUR DE CHAÎNE
BOLT AND NUT FOR BLOCK AXLE

01 N° GB5783-M8X40-W (VIS/ SCREW)
02 N° FB6170-M8-W (ÉCROU/ NUT)



AXE BRAS OSCILLANT
AXLE SWING ARM

01 N° YC110-10-034 (Ø 12/ L: 192mm: START)
01 N° YC110-10-037 (Ø 12/ L: 205mm: LITE)
01 N° YC110-10-033 (Ø 12/ L: 236mm: FACTORY 2012-25)
01 N° YC110-10-035 (Ø 12/ L: 240mm: PILOT)
02 N° YC110-1009-01 (Ø 15: PILOT/ BIGY 2018-25)

ROULEMENT BRAS OSCILLANT
SWING ARM BEARING

03 N° 6200/30-10 (Ø EXT, 30/ Ø INT, 10)
03 N° 6001/28-10 (Ø EXT, 28/ Ø INT, 10)
03 N° 6001/28-12-08 (Ø EXT, 28/ Ø INT, 12)(START/ FACTORY)
03 N° 6001/28-15-08 (Ø EXT, 28/ Ø INT, 15) (PILOT/ BIGY 2018-25)



ROULETTE CHAÎNE
CHAIN TENSIONER

01 N° YC110-2201-02
01 N° YC50-2201-02 (50E-W88)
01 N° YC110-2201-03 (SP3)

GUIDE CHAÎNE ARRIÈRE
REAR CHAIN GUIDE

02 N° YC110-1004 (PILOT 2012-24 - BIGY 2017-24)
03 N° YC110-1005 (START - LITE) SE MONTE SUR TOUS LES MODÈLES À PARTIR DE 2025/ ALL MODELS FROM 2025



GUIDE CHAÎNE RENFORCÉ FACTORY 2019-24 ADAPTABLE SUR TOUTES LES PILOT/ FACTORY/ BIGY

2019-24 FACTORY REINFORCED CHAIN GUIDE SUITABLE FOR ALL PILOT/ FACTORY/ BIGY

N° YC110-1018-04



PATIN CHAÎNE START 2011-2024

CHAIN SLIDER FOR START 2011-2024

01 N° YC110-10-023

PATIN BRAS OSCILLANT POUR BRAS 420mm OU 460mm 2011-2025

SWING ARM SLIDER FOR 420mm OR 460mm ARM 2011-2025

02 N° YC110-10-025 (TOUS LES MODÈLES À PARTIR DE 2025/ ALL MODELS FROM 2025)

PATIN BRAS OSCILLANT CANTILEVER LITE

LITE CANTILEVER SWING ARM SLIDER

03 N° YC110-1005-02

PATIN CHAÎNE COURT POUR BRAS CANTILEVER

SHORT CHAIN SLIDER ADAPTABLE FOR CANTILEVER ARM

04 N° YC110-10-021

AMORTISSEURS SHOCK ABSORBERS

FACTORY
SPECIAL PARTS
YCF RACING



AMORTISSEUR
SHOCK ABSORBER

- 01 N° YC50-0404-03 (200mm YCF 50)
- 02 N° YC110-0404-82 (270mm CANTILVER - LITE 88 - 125)
- 03 N° YC110-0404-15 (265mm MONO ARM/ BRAS - START F88)
- 03 N° YC110-0404-14 (270mm MONO ARM/ BRAS - START F125)
- 03 N° YC110-0404-17 (310mm MONO ARM/ BRAS - PILOT 125/150 2013-20 & SM150 2013-25)
- 03 N° YC110-0404-81 (330mm MONO ARM/BRAS PILOT 125/150 2020-25)
- 03 N° YC110-0404-67 (355mm MONO ARM/ BRAS - BIGY)
- 04 N° YC110-0404-07 (280mm RÉGLABLE/ ADJUSTABLE)
- 04 N° YC110-0404-16 (330mm RÉGLABLE/ ADJUSTABLE - SP2)
- 04 N° YC110-0404-68 (355mm RÉGLABLE/ ADJUSTABLE - BIGY)

ENTRETOISE D'AMORTISSEUR Ø 12
SHOCK ABSORBER SPACERS Ø 12

- 05 N° YC110-0419 (START/ PILOT 2010-2025)
- 06 N° YC110-04192 (RSP, CLASSIC, FACTORY 2010-2025)



AMORTISSEUR DNM
DNM SHOCK ABSORBER

- N° YC110-0404-83 270mm ressort/spring 800lbs
- N° YC110-0404-84 270mm ressort/spring 1000lbs
- N° YC110-0404-35 310mm ressort/spring 1000lbs
- N° YC110-0404-59 330mm ressort/spring 1000lbs
- N° YC110-0404-99 355mm ressort/spring 800 lbs (BIGY)



RESSORT PLUS SOUPLE ET PLUS DUR
SOFTER AND HARDER SPRING

- 01 N° YC110-0417-22-WH (START/ SM 88-125)
- N° YC110-0417-23-WH (PILOT 125-150/ SM 150) (SOUPLE 600 lbs)
- 02 N° YC110-0417-27-BK (START/ SM 88-125)
- N° YC110-0417-28-BK (PILOT 125-150/ SM 150) (DUR 800 lbs)
- 03 N° YC110-0417-46-BK 355mm 1000 LBS (BIGY)



BAVETTE D'AMORTISSEUR YCF
YCF MUD FLAP

- N° YC110-0460-01 (POUR/FOR PILOT/ FACTORY/ BIGY)



KIT RABAISSE AMORTISSEUR
HEIGHT ADJUSTMENT KIT

- 01 N° YC110-1033-01 (START 88S-125-125S)
- 02 N° YC110-1030-02 (LITE)



ROUES, JANTES & MOYEUX WHEELS, RIMS & HUBS



KIT ROUE SUPERMOTO YCF
YCF SUPERMOTO WHEEL SET

N° YC110-0625-01-BK (2.15 X 10" AV/ FRONT - 2.50 X 10" AR/ REAR)
N° YC110-0626-01-BK (2.15 X 12" AV/ FRONT - 2.75 X 12" AR/REAR)



VALVE COUDE 90° NOIR/GRIS - VENDUES PAR PAIRE
YCF 90° INNER TIRE VALVES BLACK/ SILVER - SOLD IN PAIRS

N° ITV01-COLOR



ROUE ACIER POUR AXE DE ROUE DE 15" AVEC RAYONS RENFORCÉS 4mm

STEEL WHEEL FOR 15" WHEEL AXLE WITH 4mm REINFORCED SPOKES

N° YC110-0601-2901 (AVANT/ FRONT 12")
 N° YC110-0601-3001-BK (AVANT/ FRONT 14")
 N° YC110-0601-0801 (88CC : AVANT/ FRONT 10")
 N° YC110-1101-3401-BK (ARRIÈRE/ REAR 12")
 N° YC110-1101-01A (ARRIÈRE/ REAR 10")



ROUE AVANT OU ARRIÈRE COMPLÈTE YCF 50

COMPLETE FRONT OR REAR WHEEL FOR YCF 50

N° YC50-0601-0401 (AVANT/ FRONT)
 N° YC50-1101-0401 (ARRIÈRE/ REAR)



ROUE COMPLÈTE AVEC MOYEURS CNC NOIRE/ BLEUE/ ROUGE/ VERTE/ ORANGE

COMPLETE WHEEL WITH CNC HUB BLACK/ BLUE/ RED/ GREEN/ ORANGE

N° YC50-0611-01+COLOR (AVANT/ FRONT)
 N° YC50-1101+COLOR (ARRIÈRE/ REAR)



ROUE COMPLÈTE ACIER RENFORCÉE POUR AXE DE ROUE DE 15", MOYEUR ARRIÈRE AVEC 5 VIS DE FIXATION POUR COURONNE

COMPLETE REINFORCED STEEL WHEEL AXLE 15", REAR HUB WITH 5 SCREWS FIXATION FOR SPROCKET

N° YC110-0601-39-BK (AVANT/ FRONT 17")
 N° YC110-1101-29-BK (ARRIÈRE/ REAR 14")



ROUE AVANT OU ARRIÈRE COMPLÈTE 16"/19" CERCEAU ALUMINIUM

COMPLETE FRONT OR REAR WHEEL 16"/19" ALUMINIUM RIM

N° YC110-0601-34-BK (1,60x19" AVANT/ FRONT)
 N° YC110-1101-72-BK (1,85 x16" ARRIERE/ REAR)

ROUE COMPLÈTE RENFORCÉE, MOYEU CNC,
CERCEAU ALU, 7116, VENDUE AVEC DISQUE & COURONNE
NOIRE/ BLEUE/ ROUGE/ VERTE/ ORANGE/ VIOLET

COMPLETE REINFORCED WHEEL, CNC HUB, ALU,
7116 RIM (SOLD WITH BRAKE DISC & SPROCKET)
BLACK/ BLUE/ RED/ GREEN/ ORANGE/ PURPLE

N° YC110-0601-40-COLOR (AVANT/ FRONT 17")
N° YC110-1101-32-COLOR (ARRIÈRE/ REAR 14")

14 17

FACTORY
SPECIAL PARTS
YCF RACING



AI 7116

YCF



CERCEAU DE ROUE ALU. 7116

ALUMINUM 7116 M SHAPE RIM

ROUE COMPLÈTE RENFORCÉE, MOYEU CNC, CERCEAU ALU, 7116, VENDUE AVEC DISQUE & COURONNE NOIRE/ BLEUE/ ROUGE/ VERTE/ ORANGE/ VIOLET
COMPLETE REINFORCED WHEEL, CNC HUB, ALU, 7116 RIM (SOLD WITH BRAKE DISC & SPROCKET) BLACK/ BLUE/ RED/ GREEN/ ORANGE/ PURPLE

Nº YC110-0601-37-COLOR (AVANT/ FRONT 14")
Nº YC110-1101-25-COLOR (ARRIÈRE/ REAR 12")

Nº YC110-1107-BK (1,85x12" AR./ REAR)
Nº YC110-1107-16-SI (1,85x12" AR./ REAR)
Nº YC110-0617-24-BK (2,50x14" AV./ FRONT)
Nº YC110-0617-24-SI (1,40x14" AV./ FRONT)
Nº YC110-0617-40-BK (1,60x17" AV./ FRONT)
Nº YC110-1107-32-BK (1,85x14" AR./ REAR)
Nº YC110-0617-41-BK (2,50x17")
Nº YC110-1107-54-BK (3.50x17")
Nº YC110-1107-55-BK (2.15x16")
Nº YC110-0617-42-BK (1.60X19")



CERCEAU DE ROUE ACIER POUR RAYON 4mm
STEEL RIM WITH 4mm SPOKES

- N° YC110-1107-34-BK (1,85X12 AR/ REAR)
- N° YC110-1101-014 (2,15X12 AV./ FRONT - AR/ REAR)
- N° YC110-0617-19-BK (1,40x12 AV./ FRONT)
- N° YC110-0617-30-BK (1,40x14 AV./ FRONT)
- N° YC110-0617-39-BK (1,60x17 AV./ FRONT)
- N° YC110-1107-29-BK (1,85x14 AR./ REAR)



ROULEMENT DE ROUE AVANT OU ARRIÈRE
FRONT OR REAR WHEEL BEARING

- 01 N° 96140-6202-2Z BEFORE 2024
- 01 N° 96140-6003-2Z (2024-25)

JOINT SPY DE ROUE
WHEEL OIL SEAL

- 02 N° YC50-0610 (Ø22X31.5X5) (POUR/ FOR YCF 50)
- 02 N° YC110-0610 (Ø25X35X6.5)
(POUR MOYEUX CNC 2012/ FOR CNC HUB)
- 02 N° YC110-0611 (Ø23X35X5) (POUR MOYEUX
INJECTÉ-CNC/ FOR MOLDED-CNC HUB)

GRIPSTER ARRIÈRE OU AVANT
REAR OR FRONT RIM LOCK

- 03 N° GRIPSTERAR-R (ARRIÈRE/ REAR)
- 03 N° GRIPSTERAV-R (AVANT/ FRONT)



JEU DE RAYONS AVANT OU ARRIÈRE 4mm
FRONT OR REAR SET OF SPOKES 4mm

AVANT/ FRONT:

- N° JR10-10.6 (50A/ 50E)
- N° JR12-12.1-8K (88E/ START 88SE)
- N° JR12-12.5 (SM)
- N° JR10-10.1-8K (LITE 88)
- N° JR14-14.8-8K (LITE 125/ START 125SE / PILOT 125/ PILOT 150)
- N° JR14-15.0-8K (SP2/ SP3)
- N° JR17-18.5-8K (BIGY F150/ 190D/ 190ZE)
- N° JR19-21.3-8K (BIGY 19")

ARRIÈRE/ REAR:

- N° JR10-10.5 (50A/ 50E)
- N° JR10-10.4-8K (88E/ LITE 88/ START 88SE)
- N° JR12-12.8-8K (LITE 125/ START 125S/ START 125SE / PILOT 125/ PILOT 150)
- N° JR12-13.5-8K (SP2/ SP3)
- N° JR12-12.6-10K (SM)
- N° JR14-15-8K (BIGY 125/ 150)
- N° JR14-15.1-8K (BIGY F150/ 190D/ 190ZE)
- N° JR16-17.5-8K (BIGY 16")



AXE DE ROUE AVANT OU ARRIÈRE
FRONT OR REAR WHEEL AXLE

- 01 N° YC110-11-075 (FACTORY 2011-2025)
- 02 N° YC110-11-07 (ARRIÈRE/ REAR)
- 03 N° YC110-06-06 (AVANT/ FRONT - LITE)
- 04 N° YC110-06-061 (TYPE MARZOCCHI®)



COUVRE RAYON (KIT DE 38 PCS AVANT 215 MM/ 38 PCS ARRIÈRE 190mm)
NOIR/ BLEU/ ROUGE/ VERT/ JAUNE/ ORANGE/ ROSE

SPOKE SKIN SET (INCLUDES 38 FRONT PCS-215mm & 38 REAR PCS-190mm)
BLACK/ BLUE/ RED/ GREEN/ YELLOW/ ORANGE/ PINK

N° SPKAS01-COLOR



MOYEU ROUE AVANT OU ARRIÈRE CNC NOIR/ BLEU/ ROUGE/ VERT/ ORANGE/ VIOLET

WHEEL HUB CNC FRONT OR REAR BLACK/ BLUE/ RED/ GREEN/ ORANGE/ PURPLE

- 01 N° YC110-0622-22+COLOR (AVANT/ FRONT)
- 02 N° YC110-1122-16+COLOR (ARRIÈRE/ REAR)

JEU ENTRETOISES DE ROUE CNC POUR MOYEU INJECTÉE LITE/ START/ PILOT/ BIGY MX125/150 NOIRES/BLEUES/ ROUGES/ VERTES/ ORANGES

SET OF CNC WHEEL SPACERS FOR CASTING HUB LITE/ START/ PILOT/ BIGY MX125/150 BLACK/ BLUE/ RED/ GREEN/ ORANGE

- 03 N° ERC1AV-COLOR (AVANT/ FRONT 15x22x33 & 15x22x23)
- 03 N° ERC1AR-COLOR (ARRIÈRE/ REAR 15x22x38 & 15x22x29)

ENTRETOISE DE ROUE

WHEEL SPACER

- 04 N° YC110-06-052 (AVANT GAUCHE/ FRONT LEFT) Ø 15X22X33 LITE/ START/ PILOT/ BIGY MX125-150 2016-2023
- 04 N° YC110-06-047 (AVANT DROITE/ FRONT RIGHT) Ø 15X22X23 LITE/ START/ PILOT/ BIGY MX125-150 2016-2023
- 04 N° YC110-11-052 (ARRIÈRE GAUCHE/ REAR LEFT) Ø 15X22X38 LITE/ START/ PILOT/ BIGY MX125-150 2016-2023
- 04 N° YC110-11-041 (ARRIÈRE DROITE/ REAR RIGHT) Ø 15X22X29 LITE/ START/ PILOT/ BIGY MX125-150 2016-2023

**KIT ENTRETOISE DE ROUE FIXE POUR MOYEU INJECTÉ**

WHEEL SPACER KIT FOR INJECTED HUB

- N° YC110-0635-01 (AVANT/ FRONT) LITE/ START/ PILOT/ BIGY125/ BIGY150MX/ SUPERMOTO/MINI GP
- N° YC110-1126-01 (ARRIÈRE / REAR) LITE/ START/ PILOT/ BIGY125/ BIGY150MX/ SUPERMOTO/MINI GP

ENTRETOISE CENTRALE DE MOYEU

CENTRAL HUB SPACER

- 05 N° YC110-0601-02 (CENTRAL AVANT/ FRONT) Ø16x22x44 (LITE/ START/ PILOT/ BIGY 2016-2023)
- 05 N° YC110-0601-0201 (CENTRAL AVANT/FRONT) Ø17X24X44 (START/ PILOT/ BIGY 2024-25)
- 05 N° YC110-0601-0607 (CENTRAL AVANT/FRONT) Ø17X24X44 (FACTORY/ BIGY FACTORY CNC HUB)
- 05 N° YC110-1101-06 (INT, ARRIÈRE/ INNER REAR) Ø16×21×74 (START/ PILOT/ BIGY 2016-2023)
- 05 N° YC110-1101-0601 (INT, ARRIÈRE/INNER REAR) Ø17X24X74 (START/ PILOT/ BIGY 2024-25 INJECTED HUB)
- 05 N° YC110-1109-07 (INT, ARRIÈRE/INNER REAR) Ø17X25X67 (FACTORY/ BIGY FACTORY CNC HUB)

ENTRETOISE SP3 2019 (TÉ 170 mm)

WHEEL SPACER

- 04 N° YC110-0609-08 (AVANT DROITE/ FRONT RIGHT)
- 04 N° YC110-0610-08 (AVANT GAUCHE/ FRONT LEFT)





↙ PNEUS TIRES



CHAMBRE À AIR RENFORCÉE 4mm
REINFORCED TUBE 4mm

01 N° CHAMBRE10RENF (Ø 10" FRONT-REAR/ AV,-AR.)
01 N° CHAMBRE12RENF (Ø 12" FRONT-REAR/ AV,-AR.)
01 N° CHAMBRE14RENF (Ø 14" AV./ FRONT)
01 N° CHAMBRE14ARRENF (Ø 14" AR./ REAR)
01 N° CHAMBRE17RENF (Ø 17" AV./ FRONT)

CHAMBRE À AIR STANDARD
STANDARD TUBE

01 N° CHAMBRE10-2,5 (Ø 10" POUR/ FOR YCF 50)
01 N° CHAMBRE12AV (Ø 12" AVANT/ FRONT)
01 N° CHAMBRE16AR
01 N° CHAMBRE17-2 (Ø 17" AV. AR./ FRONT-REAR)
01 N° CHAMBRE19AV

FOND JANTE
TIRE LINING

02 N° YC110-11-01 (ROUE/ WHEEL 10/12")
02 N° YC110-06-01 (ROUE/ WHEEL 14")
02 N° YC110-06-02 (ROUE/ WHEEL 16")
02 N° YC110-06-07 (ROUE/ WHEEL 17")
02 N° YC110-06-08 (ROUE/ WHEEL 20")



BOUCHON DE VALVE CNC
NOIR/ BLEU/ ROUGE/ VERT/ ORANGE/VIOLET
VALVE CAP SET
BLACK/ BLUE/ RED/ GREEN/ ORANGE/ PURPLE

N° TVC-COLOR



PNEU AVANT CROSS 2,50/10
FRONT MX TIRE IN 2,50/10

N° 250/10



PNEU AVANT CROSS EN 60/100/12
FRONT MX TIRE IN 60/100/12

N° 60/100/12



PNEU ARRIÈRE CROSS EN 90/100/14
REAR MX TIRE IN 90/100/14

N° 90/100-14P398



PNEU ARRIÈRE CROSS EN 3,00/10
REAR MX TIRE IN 3,00/10

N° 300/10



PNEU ARRIÈRE CROSS EN 80/100/12
REAR MX TIRE IN 80/100/12

N° 300/12



PNEU AVANT CROSS EN 70/100/17
FRONT MX TIRE IN 70/100/17

N° 70/100-17P397



PNEU AVANT CROSS EN 60/100/14
FRONT MX TIRE IN 60/100/14

N° 60/100/14



PNEU ARRIÈRE CROSS EN 90/100-16P52
REAR MX TIRE IN 90/100-16P52

N° 90/100-16P52



PNEU AVANT CROSS EN 70/100-19P51
FRONT MX TIRE IN 70/100-19P51

N° 70/100-19P51



PNEU 90/90/10
TIRE 90/90/10

N° 90/90/10

KENDA



10 12

PNEU KENDA® SUPERMOTARD K702
KENDA® SUPERMOTO TIRE K702

№ 90/90-10K702
№ 100/90-10K702
№ 110/70-12K702
№ 120/70-12K702



GP



PAIRE DE COUVERTURE CHAUFFANTE AVEC BOITIER DE RÉGLAGE INDEPENDANT JUSQU'À 99 DEGRES
TIRE WARMERS WITH INDEPENDANT ADJUSTABLE TEMPERATURE CONTROL (UP TO 99 DEGREES)

№ YC110-1125-01-BK

ARRO™



10

PNEU ARRO® SPIDER CROSS EN 300/10
SPIDER ARRO® TIRE 300/10

№ 300/10 ARRO

ARRO™



12

PNEU ARRO® SPIDER CROSS AVANT EN 60/100/12
SPIDER ARRO® TIRE FRONT 60/100/12

№ 60/100/12 ARRO

ARRO™



12

PNEU ARRO® SPIDER CROSS ARR, EN 80/100/12
SPIDER ARRO® TIRE REAR 80/100/12

№ 80/100/12 ARRO

ARRO™



14

PNEU ARRO® SPIDER CROSS AVANT EN 60/100/14
SPIDER ARRO® TIRE FRONT 60/100/14

№ 60/100/14 ARRO

ARRO™



17

PNEU AVANT SUPERMOTARD KENDA® K711
FRONT SUPERMOTO TIRE KENDA K711

№ 110/70-17K711

ARRO™



17

PNEU ARRIÈRE SUPERMOTARD KENDA® K711
REAR SUPERMOTO TIRE KENDA K711

№ 130/70-17K711

REPOSE-PIEDS & SABOTS FOOT PEGS & SKID PLATES



FACTORY
SPECIAL PARTS
YCF RACING

JEU DE REPOSE-PIED ALUMINIUM NOIR/ BLEU/ ROUGE/ VERT/ ORANGE/ VIOLET
ALUMINUM FOOT PEGS BLACK/ BLUE/ RED/ GREEN/ ORANGE/ PURPLE

N° RPALU-COLOR

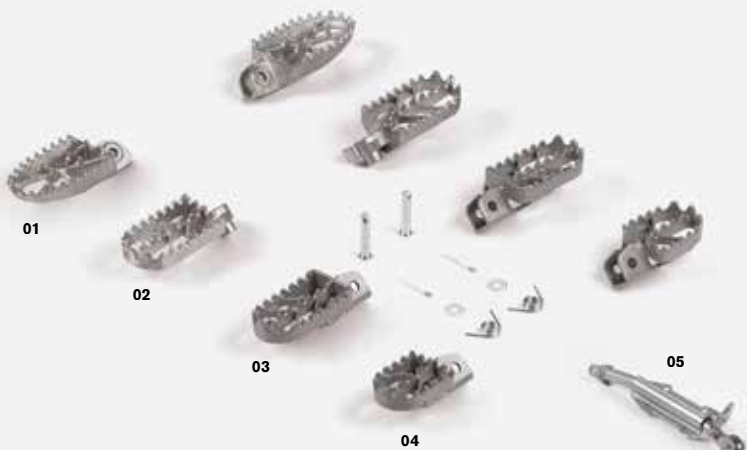

JEU DE REPOSE-PIED
FOOT PEGS SET

- 01 N° YC110-0902/05 (INOX LARGE/ LARGE STAINLESS STEEL)
- 02 N° YC110-0902/04 (INOX/ STAINLESS STEEL)
- 03 N° YC110-0902/17 (ACIER/ STEEL)
- 04 N° YC110-0902/06 (SUPERMOTO)
- 05 N° YC110-0901-01 (GAMME START/ START RANGE)



SABOT RÉCUPERATEUR HUILE SUPERMOTARD EN FIBRE DE VERRE BLANC/ NOIR

RACE BELLY PAN WHITE/ BLACK

N° YC110-202-03-WH
N° YC110-202-03-BK
(Adaptable sur toute la gamme YCF/ fit on all YCF range)



KIT COMPLET PROTECTION TEFLON SUPERMOTO
SUPERMOTO TEFLON PROTECTION SET

N° KS1



KIT PATIN TEFLON SUPERMOTO
SUPERMOTO TEFLON SET

N° KS4



RÉSERVOIR RÉCUPERATEUR DE LIQUIDE AVEC SEPARATEUR HUILE/ ESSENCE

CATCH CAN WITH SEPARATOR OIL/ GAZ

N° YC110-0816-02



KIT BOCAL RÉCUPERATEUR HUILE ET ESSENCE SUPERMOTO

SUPERMOTO OIL AND FUEL CATCH CAN

N° KS3



SABOT POUR FACTORY
SKID PLATE FOR FACTORY

N° YC110-207-12 (LITE/START/PILOT) (kickstart model)
N° YC110-207-03 (FACTORY SP1)
N° YC110-207-04 (FACTORY SP2)
N° YC110-207-05 (FACTORY SP3)



SÉLECTEUR ACIER REPLIABLE
FOLDABLE STEEL SHIFT LEVER

01 N° 24700/152FMH/04 LITE/ START 88SE/ START 125SE/ START 125/ PILOT 150E/ SUNDAY 124 (AVEC DÉPORT/ WITH EXT.)
01 N° 24700/152FMH/02 (190 ZONGSHEN ENGINE)
02 N° 24700/152FMH/03 PILOT 125/ FACTORY/ BIGY/ SM/ SUNDAY 157/ SUNDAY 187/ GP

SÉLECTEUR ACIER REPLIABLE ET RÉGLABLE
FOLDABLE & ADJUSTABLE STEEL SHIFT LEVER

03 N° 24700-D LITE/ START 88SE/ START 125SE/ START 125/ PILOT 150E/ SUNDAY 124 (AVEC DÉPORT/ WITH EXT.)
04 N° 24700-SD PILOT 125/ FACTORY/ BIGY/ SM/ SUNDAY 157/ SUNDAY 187/ GP

↙ SÉLECTEURS SHIFT LEVERS



SÉLECTEUR ALUMINIUM CNC AVEC DÉPORT POUR AXE SÉLECTEUR COURT
NOIR/ BLEU/ ROUGE/ ORANGE/ VERT/ VIOLET
ALUMINUM CNC GEAR LEVER WITH EXTENSION FOR SHORT LEVER SHAFT
BLACK/ BLUE/ RED/ ORANGE/ GREEN/ PURPLE

01 N° STMD-COLOR LITE/ START 88SE / START 125SE/ START 125/ PILOT 150E/ SUNDAY 124

SÉLECTEUR FORGÉ NOIR/ BLEU/ ROUGE/ ORANGE/ VERT/ VIOLET
FORGED GEARSHIFT BLACK/ BLUE/ RED/ ORANGE/ GREEN/ PURPLE

02 N° 24700-01-COLOR PILOT 125/ FACTORY/ BIGY/ SM/ SUNDAY 157/ SUNDAY 187/ GP



KICK ACIER ORIGINE
ORIGINAL STEEL KICKSTARTER

01 N° 43451/152FMH (Ø 13mm)
01 N° 43452/152FMH (Ø 16mm)

KICK ACIER RENFORCÉ
REINFORCED KICKSTARTER

02 N° YC140-27500SI (Ø 13mm)
02 N° YC140-27600SI (Ø 16mm)

RESSORT/ BILLE/ VIS POUR KICK
BALL, SPRING, AND SCREW FOR KICKSTARTER

03 N° KVK



KIT CHAÎNE & TRANSMISSION

SPROCKET KITS & TRANSMISSIONS

SPECIAL PARTS
YCF RACING



41 45

COURONNE ACIER Ø INTÉRIEUR 75 - ENTRAXE COURONNE 92 - 5 TROUS DE FIXATION POUR FACTORY 2016-25

STEEL SPROCKET INNER Ø 75 - SPROCKET CENTER TO CENTER DISTANCE 92 - 5 HOLES FIXATION FOR FACTORY 2016-25

N° YC110-11-062/41 (41 DENTS/ TEETH)

N° YC110-11-062/45 (45 DENTS/ TEETH)

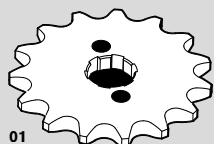

01

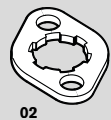

02



03

PIGNON SORTIE BOÎTE & PLAQUE PIGNON

COUNTERSHAFT SPROCKET & SPROCKET PLATE

01 N° 22711/152FMI14 (Ø 20 PIGNON 14 DENTS/ SPROCKET 14 TEETH)

01 N° 22711/152FMI15 (Ø 20 PIGNON 15 DENTS/ SPROCKET 15 TEETH)

02 N° 22712/152FMH (Ø 17 PLAQUE PIGNON/ SPROCKET PLATE)

02 N° 22712/152FMI (Ø 20 PLAQUE PIGNON/ SPROCKET PLATE)

03 N° RS35/10T (PIGNON 10 DENTS/ SPROCKET 10 TEETH) YCF 50E

03 N° RS35-10T-01 (PIGNON 10 DENTS/ SPROCKET 10 TEETH) W88 2020-21

03 N° RS35-11T-01 (PIGNON 420 11 DENTS / SPROCKET 11 TEETH 420) W88 2022-25

SPECIAL PARTS
YCF RACING



CHAÎNE RENFORCÉE 420 116 MAILLONS BLEUE/ ROUGE/ VERTE/ JAUNE/ ORANGE
REINFORCED CHAIN 420 116 LINKS BLUE/ RED/ GREEN/ YELLOW/ ORANGE

N° 420-116T-COLOR

SPECIAL PARTS
YCF RACING



39 41 45



60

COURONNE ACIER Ø INTÉRIEUR 75 - ENTRAXE COURONNE 92

STEEL SPROCKET INNER Ø 75 - SPROCKET CENTER TO CENTER DISTANCE 92

01 N° YC110-11-06/39 (39 DENTS/ TEETH)

01 N° YC110-11-06/41 (41 DENTS/ TEETH)

01 N° YC110-11-06/45 (45 DENTS/ TEETH)

02 N° YC110-11-05/60 (60 DENTS/ TEETH - YCF 50E/ W88)

SPECIAL PARTS
YCF RACING



PIGNON SORTIE BOÎTE ANTI BOUE Ø 17
ANTI MUD COUNTERSHAFT SPROCKET Ø 17

N° 22711/152FMZ13 (13 DENTS/ TEETH)

N° 22711/152FMZ14 (14 DENTS/ TEETH)

N° 22711/152FMZ15 (15 DENTS/ TEETH)

N° 22711/152FMZ16 (16 DENTS/ TEETH)

N° 22711/152FMZ17 (17 DENTS/ TEETH)

N° 22711/152FMZ18 (18 DENTS/ TEETH)

N° 420H/10T (10 DENTS/ TEETH) (YCF 50A)

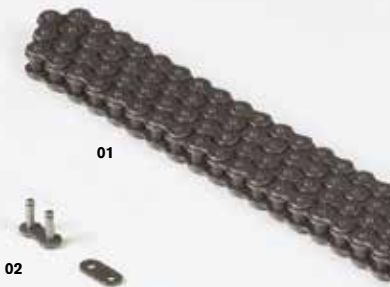

01

02

CHAÎNE 420 ET RS35

CHAIN 420 AND RS35

01 N° 420H-104T (104 MAILLONS/ LINKS)

01 N° 420H-110T (110 MAILLONS/ LINKS)

01 N° 420H-116T (116 MAILLONS/ LINKS BIGY)

01 N° 420DX-120T (120 MAILLONS/ LINKS BIGY 16-19)

01 N° RS35-114T (114 MAILLONS/ LINKS 50E)

ATTACHE RAPIDE

CHAIN JOINING LINK

02 N° AR-420

02 N° AR-35 (YCF 50E)



32 34 35 36 37 39 40 41 42 43 45 47



COURONNE ALU. TAILLÉE DANS LA MASSE DISPONIBLE EN 32, 34, 35, 36, 37, 39, 40, 41, 42, 43, 45, 47 DENTS NOIRE/ BLEUE/ ROUGE/ VERTE/ ORANGE Ø INTÉRIEUR 75 - ENTRAXE COURONNE 92

BILLET ALUMINUM SPROCKET AVAILABLE IN 32, 34, 35, 36, 37, 39, 40, 41, 42, 43, 45, 47 TEETH BLACK/ BLUE/ RED/ GREEN/ ORANGE INNER Ø 75 - SPROCKET CENTER TO CENTER DISTANCE 92

N° CA06R+TEETH-COLOR
(YCF50A - LITE - START - PILOT - SM)



KIT VIS COURONNE
SCREW SET FOR SPROCKET

01 N° KVC
02 N° KVC-1 (TÊTE FRAISÉE/ FLAT HEAD)
04 N° KVC-2 (KIT VIS PLATES/ SCREW KIT FLAT HEAD)

BLOC COURONNE
BLOCK SPROCKET

03 N° YC110-11-03



TENDEUR CHAÎNE CNC NOIR/ BLEU/ ROUGE/ VERT/ ORANGE/ VIOLET
CNC AXLE BLOCK BLACK/ BLUE/ RED/ GREEN/ ORANGE/ PURPLE

01 N° TC07-COLOR (Ø 15) (POUR BRAS ACIER/ FOR STEEL SWING ARM) (START/ PILOT)
02 N° TC12-COLOR (POUR BRAS ALU/ FOR ALU SWING ARM - 2011-2025) (FACTORY/ BIGY)



41 43 45 47



COURONNE ALU, TAILLÉE DANS LA MASSE - 5 TROUS DE FIXATION POUR FACTORY 2016-2025 - DISPONIBLE EN 41, 43, 45, 47 DENTS NOIRE/ BLEUE/ ROUGE/ VERTE/ ORANGE - Ø INTÉRIEUR 75 - ENTRAXE COURONNE 92

BILLET ALUMINUM SPROCKET - 5 HOLE FIXATION FOR FACTORY 2016-2025 - AVAILABLE IN 41, 43, 45, 47 TEETH BLACK/ BLUE/ RED/ GREEN/ ORANGE - INNER Ø 75 - SPROCKET CENTER TO CENTER DISTANCE 92

N° CA16R+TEETH-COLOR
(FACTORY-BIGY)



PROTECTION PIGNON SORTIE BOÎTE (VIS & ENTRETOISES INCLUSES)
COUNTERSHAFT SPROCKET GUARD (SCREWS & SPACERS INCLUDED)

01 N° YC110-1803-BK (ELECTRIC START ENGINE) (START SE 88/ START SE 125/ PILOT 150 E/ BIGY 150 FACTORY E)
02 N° YC110-1803-02-BK (LITE /START 125/PILOT 125/BIGY125-150/BIGY190 DAYTONA)



CLÉ À BOUGIE
SPARK PLUG REMOVAL TOOL

01 N° CB

ARRACHE VOLANT 3 EN 1
ADAPTABLE SUR TOUS LES MOTEURS DE MINI
FLYWHEEL REMOVER 3 IN 1
SUITABLE FOR ALL MINI BIKES ENGINES

02 N° ARRACHE-1

OUTIL POUR DÉMONTER NOIX EMBRAYAGE ET ÉPURATEUR
CLUTCH TOOL

03 N° OUTIL

DÉRIVE CHAÎNE PROFESSIONNEL
PROFESSIONAL CHAIN TOOL

04 N° DERIVE-1

CLÉ À RAYONS
SPOKE WRENCH

05 N° CLEARAYON-02

JEU DE CALES MOTEUR
ENGINE FEELER GAUGES

06 N° JCM-1

DÉMONTE PNEU EN CUILLÈRE
SPOON TIRE LEVER

07 N° DEMONT-1

OUTIL RÉGLAGE SOUPAPES
VALVE ADJUSTMENT TOOL/ WRENCH

10 N° YC110-2410-01

FREIN FILET - ROUGE : FORT / BLEU : MOYEN
THREADLOCKER - RED: STRONG/ BLUE: MEDIUM

08 N° FF271 (STRONG/ FORT)
09 N° FF242 (MEDIUM/ MOYEN)





KIT DÉPART ENGI®
ENGI® LAUNCH CONTROL

N° ENGIHKF-BK



BAGUE/ JOINT SPI/ CACHE POUSSIÈRE FOURCHE
FORK RING/ OIL SEAL/ DUST COVER

- 01 N° EF03-0027-BC (INFERIEURE/ LOWER)
 - 02 N° EF03-0005 (SUPÉRIEURE/ UPPER)
 - 03 N° EF03-0009-01 (ENGI®)
 - 04 N° EF03-0011-01 (ENGI®)
- (VENDU À L'UNITÉ/ SELL BY UNIT)



FOURCHE ENGI® RÉGLABLE COMPRESSION DÉTENTE AVEC CORPS ALUMINIUM ET TRAITEMENT DU TUBE INF.
ENGI® FORK WITH ADJUSTABLE COMPRESSION & REBOUND

N° ENGI2-800-GY (800mm)



FOURCHE ENGI® RÉGLABLE COMPRESSION DÉTENTE
ENGI® FORK WITH ADJUSTABLE COMPRESSION & REBOUND

N° ENGI2-735-GY (735mm)



OUTIL CLÉ EN T ENGI®
ENGI® T-HANDLE WRENCH TOOL

01 N° ENGI-PDR

OUTIL DÉMONTAGE BOUCHON (du haut) ENGI®
ENGI® PLUG REMOVAL TOOL

02 N° ENGI-FCW

OUTIL DE TIGE INTÉRIEURE DE FOURCHE ENGI®
ENGI® INTERNAL FORK STEM TOOL

03 N° ENGI-DAT



AMORTISSEUR ENGI® RÉGLABLE DÉTENTE
ENGI® SHOCK ABSORBER ADJUSTABLE REBOUND

- N° YC110-0404-65 (270mm START)
- N° YC110-0404-66 (310mm PILOT 2013-19/ SM 2013-25)
- N° YC110-0404-61 (330mm SP2/ PILOT 20-25)
- N° YC110-0404-63 (335mm SP3)
- N° YC110-0404-69 (355mm BIGY)



KIT RÉFECTION INTERIEUR AMORTISSEUR
ENGI® SHOCK INTERNAL REPAIR KIT

N° ES01-000B



KIT RÉFECTION ENTRETOISE AXE AMORTISSEUR
ENGI® SHOCK SPACER KIT

N° ES01-000C



FACTORY



SPECIAL PARTS
YCF RACING

01



- 01 **KIT ROUE SUPERMOTO YCF/ YCF SUPERMOTO WHEEL SET** PAGE 105
N° YC110-0626-01-BK
- 02 **PROTÈGE LEVIER TYPE MOTO GP/ MOTOGP STYLE LEVER PROTECTION** PAGE 84
N° YC110-14-072BK
- 03 **POIGNÉE CAOUTCHOUC/ RUBBER GRIPS** PAGE 87
N° PPC011+COLOR
- 04 **MAÎTRE CYLINDRE FREIN AVANT/ FRONT BRAKE MASTER CYLINDER** PAGE 94
N° YC110-0507-01
- 05 **GUIDON/ HANDLEBAR** PAGE 85
N° GALOW+COLOR

**PIECES
USINES
CNC
ALUMINIUM
MULTICOLORES**

MULTICOLOR
FACTORY
CNC
ALUMINIUM
PARTS



PIECES RACING SUPERMOTARD SUPERMOTARD RACING PARTS

FACTORY
SPECIAL PARTS
YCF RACING



- | | |
|-----------------------------------------------------------------------------------------|---------|
| 01 BÉQUILLE ROUE ARRIÈRE/ REAR STAND
N° STAND1MOTO-04 | PAGE 67 |
| 02 VALVE PRISE AIR/ FUEL VENT VALVE
N° YC125-0704+COLOR | PAGE 93 |
| 03 DONUTS/ GRIP DONUTS
N° DONUTZ-02+COLOR | PAGE 87 |
| 04 PASSE DURITE FREIN AVANT/ STEEL BRAKE LINE RETAINER
N° YC110-0403-06+COLOR | PAGE 82 |

ENGINE PARTS

PIÈCES MOTEUR

MOTEURS DAYTONA®/ DAYTONA® ENGINES	126
MOTEURS/ ENGINES	126
KITS MOTEUR/ ENGINE KITS	128
EMBAYAGE/ CLUTCH	131
CARBURATEURS/ CARBURETORS	133
FILTRES À AIR/ AIR FILTERS	135
ÉCHAPPEMENTS/ EXHAUSTS	136
FILTRES & RADIATEURS/ FILTERS & COOLERS	139
ALLUMAGE/ IGNITION	140
PIÈCES RACING DAYTONA®/ DAYTONA® RACING PARTS	142
PIÈCES D'ORIGINE DAYTONA®/ DAYTONA® PARTS	143



MOTEURS ENGINES

DAYTONA®

DAYTONA® EST UNE SOCIÉTÉ JAPONNAISE SPÉCIALISÉE DANS LE DÉVELOPPEMENT ET LA FABRICATION DE PIÈCES HAUTE PERFORMANCE MOTOS DEPUIS 1972. L'ENTREPRISE EST UN LEADER INTERNATIONAL DE L'INDUSTRIE DES PIÈCES RACING.
(DÉTAIL DES PIÈCES À PARTIR DE LA PAGE 130)

DAYTONA® IS A JAPANESE COMPANY SPECIALIZING IN HIGH PERFORMANCE MOTORCYCLE PARTS. THEY HAVE BEEN A LEADER IN THE MOTORCYCLE INDUSTRY SINCE 1972. DAYTONA PROVIDES MOTORCYCLE RACING PARTS, AS WELL AS OE MOTORCYCLE PARTS, TO THE ENTIRE INTERNATIONAL MARKETPLACE. (SEE PARTS DETAILS STARTING ON PAGE 130)

CARTER RENFORCÉ
REINFORCED CRANKCASE



FEATURING

DÉCOMPRESSEUR AUTOMATIQUE
DECOMPRESSION SYSTEM



DAYTONA



ANIMA® 2.0 MX

MOTEURS DAYTONA® ANIMA® 2,0
DAYTONA® ANIMA® 2.0 ENGINES

N° 88025 (ANIMA® 160cc, FSM, 4 SPEEDS)
N° 81244 (190cc, SYS, 4 SPEEDS)



MOTEUR DAYTONA® 190cc FE DÉMARREUR ÉLECTRIQUE 5 VITESSES
DAYTONA® 190cc FE ENGINE ELECTRIC START 5 SPEEDS

N° 88392

ZONGSHEN



MOTEUR ZONGSHEN® FIDDY
ZONGSHEN® FIDDY ENGINE

N° MOTEUR110-G
N° MOTEUR125-G
N° MOTEUR155-G

MOTEUR 50 YCF 2012-2020 AUTOMATIQUE
YCF 50 ENGINE 2012-2020 AUTOMATIC

01 N° MOTEUR50-01-GY

MOTEUR 88 4 VITESSES SEMI-AUTOMATIQUE
88 4 SPEED SEMI-AUTOMATIC ENGINE

02 N° MOTEUR88

MOTEUR 88 À DÉMARREUR
88 4 SPEED SEMI-AUTOMATIC ENGINE ELECTRIC START

03 N° MOTEUR88ELE-02

MOTEUR 110 AUTOMATIQUE
110 ENGINE AUTOMATIC

04 N° MOTEUR110ZS-SE-AUTOMATIC

MOTEUR 125 4 VITESSES SEMI-AUTOMATIQUE
125 4 SPEED SEMI-AUTOMATIC ENGINE

05 N° MOTEUR125SEMI

MOTEUR 125 À DÉMARREUR
125 4 SPEED SEMI-AUTOMATIC ENGINE ELECTRIC START

06 N° MOTEUR125SELE-01

MOTEUR 125 POINT MORT
125 NEUTRAL ENGINE

07 N° MOTEUR125P

MOTEUR 150-3
150-3 ENGINE

08 N° MOTEUR150-3

MOTEUR 150 TYPE CRF
150 ENGINE TYPE CRF

09 N° MOTEUR150-5

MOTEUR 150 YX DÉMARREUR ÉLECTRIQUE
150 YX ENGINE ELECTRIC START

10 N° MOTEUR150-3E

MOTEUR150-2E DÉMARREUR ÉLECTRIQUE TYPE KLX
150-2E ENGINE ELECTRIC START KLX TYPE

11 N° MOTEUR150-2E

MOTEUR 150 TYPE KLX
150 ENGINE TYPE KLX

12 N° MOTEUR150-2



01



02



06



03



07



10



04



08



05



09



11



12



KITS MOTEUR & PIÈCES **ENGINE KITS & PARTS**



CHAÎNE DE DISTRIBUTION
TIMING SPROCKET

N° D00F012 (84 MAILLONS POUR 125cc POINT MORT ET SEMI-AUTOMATIQUE/ 84 LINKS FOR 125cc NEUTRAL START AND SEMI-AUTOMATIC)
 N° 14350/152FMI (90 MAILLONS POUR 125/ 140/ 150 CRF/ 90 LINKS FOR 125/ 140/ 150 CRF TYPE)
 N° 210F012 (POUR YX 150/ 160 TYPE KLX/ FOR 150/ 160 YX KLX TYPE)



BOUCHON CARTER ALUMAGE YCF CNC
NOIR/ BLEU/ ROUGE/ VERT/ ORANGE/ VIOLET
 ALUMINIUM CAP BIG VIEW HOLE FOR YCF COVER
 BLACK/ BLUE/ RED/ GREEN/ ORANGE/ PURPLE

N° YC110-2014-01+COLOR



CARTER D'ALLUMAGE POUR DÉMARREUR ÉLECTRIQUE
IGNITION COVER ELECTRIC START

01 N° 12301-D083-000189
 02 N° 90204-D083-000



NOUVEAU CARTER D'ALLUMAGE YCF (Pour démarrage au kick)
NEW YCF IGNITION COVER (kickstart only)

01 N° YC110-2004-01-GY (GRIS/GREY)
 02 N° YC110-2004-01-BK (NOIR/BLACK)
 03 N° YC110-2004-01-MG (MAGNESIUM)



CARTER D'ALLUMAGE
IGNITION COVER

- 01 N° 11411/152FMH (CARTER D'ALLUMAGE/ IGNITION COVER)
- 02 N° 11411/152FMH-MG (CARTER D'ALLUMAGE/ IGNITION COVER)
- 03 N° 11411/152FMH-BK (CARTER D'ALLUMAGE/ IGNITION COVER)
- 04 N° 11419/152FMH (JOINT CARTER ALLUMAGE/ IGNITION COVER GASKET)
- 05 N° A00-8-1(CARTER ALLUMAGE LITE 88/125)



CHAÎNE DE DÉMARREUR
STARTER CHAIN

- 01 N° 2141B-IA29-0000 POUR MOTEUR/ FOR ENGINE 88-125 SE
- 02 N° 100061493 POUR MOTEUR/ FOR ENGINE 190 ZONGSHEN®



KIT PISTON
PISTON KIT

- N° KPC/39-13 (YCF 50)
- N° KPC/44-13 (YCF 50A 2012-24)
- N° KPC/47-13 (88 CC Ø 46,5 AXE 13)
- N° KPC/52,5-13 (88/107/120/125 CC Ø 52,5 AXE 13)
- N° KPC/54-13ZS (110/125 ZONGSHEN FIDDY)
- N° KPC/52,5-14 (120/125 CC Ø 52,5 AXE 14)
- N° KPC/54-14 (120/125 CC Ø 54 AXE 14)
- N° KPC/56-13 (140/150 YX TYPE CRF Ø 56 AXE 13)
- N° KPC/60-13 (150-160 YX TYPE KLX Ø 60 AXE 13)
- N° KPC/60-13ZS (155 ZONGSHEN)

JEU DE SEGMENTS SEUL
PISTON RINGS SET ONLY

- N° 13300F (88 CC Ø 46,5)
- N° 13300/152FMI (107-125 CC Ø 52,5)
- N° 13300/152FMH (125-138 CC Ø 54)
- N° 13300 (140 CC Ø 55)
- N° 208J013 (140-150 CC Ø 56)
- N° 210J013 (150 CC Ø 60)

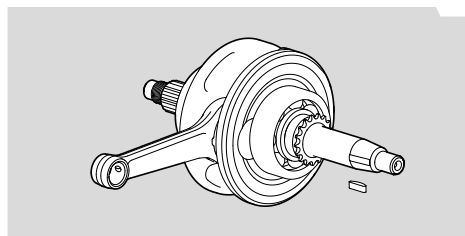

VILEBREQUIN
CRANKSHAFT

- N° 208J000 (125/140 YX AXE PISTON 13)
- N° 216J000 (150 CRFAE PISTON 13)
- N° 2104J000 (150 KLX)
- N° 2043J000 (125 POINT MORT)



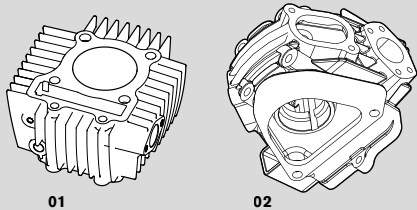

CYLINDRES & CULASSES

CYLINDERS & CYLINDER HEADS

- 01 N° 206A038 (125 YX 52,5mm)
- 01 N° 2081A038 (140 YX 56mm)
- 01 N° 208A038 (150 YX TYPE CRF)
- 01 N° 210A038 (150 YX TYPE KLX)
- 01 N° 204A038 (125 YX 54mm)

- 02 N° 206A000 (125 YX)
- 02 N° 208A000 (140/150 YX TYPE CRF)
- 02 N° 210A000 (150/160 YX TYPE KLX)

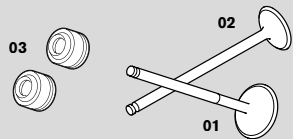

SOUPAPE D'ADMISSION

INLET VALVE

- 01 N° 206F045 (125 YX Ø 24)
- 01 N° 14710/152FMI (125, 140, 150 Ø 27)
- 01 N° 210F045 (KLX)

SOUPAPE D'ÉCHAPEMENT

EXHAUST VALVE

- 02 N° 206F039 (125 YX Ø 21)
- 02 N° 14720/152FMI (125, 140, 150 Ø 23)
- 02 N° 210F039 (KLX 4V)

JOINT QUEUE SOUPAPE

VALVE STEM SEAL

- 03 N° 14730/152FMH

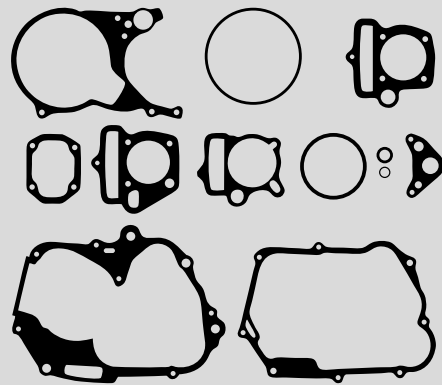

POCHETTE JOINTS COMPLÈTE

COMPLETE GASKET SET

- N° PJCM50 (50S YCF 2010-2011)
- N° PJCM50-2 (50A YCF 2012-2025)
- N° PJCM88 (88 CC)
- N° PJCMSE (START F88SE/ F125SE)
- N° PJCM125 (125 CC)
- N° PJCM125-G (110/125 ZONGSHEN FIDDY)
- N° PJCM140 (140 CC)
- N° PJCM150CRF (150 CC)
- N° PJCM150KLX (150 CC TYPE KLX)
- N° PJCM150-3E (PILOT F150E 2022-25)
- N° PJCM155-G (155 ZONGSHEN)



POCHETTE JOINTS HAUT MOTEUR

GASKET SET TOP END

- N° PJHM50 (50S YCF 2010-2011)
- N° PJHM50-2 (50A YCF 2012-2025)
- N° PJHM88 (88 CC)
- N° PJHM125 (125 CC)
- N° PJHM125-G (110/125 ZONGSHEN FIDDY)
- N° PJHM140 (140 CC)
- N° PJHM150CRF (150 CC)
- N° PJHM150KLX (150 CC TYPE KLX)
- N° PJHM150-3E (PILOT F150E 2022-25)
- N° PJHM155-G (155 ZONGSHEN)

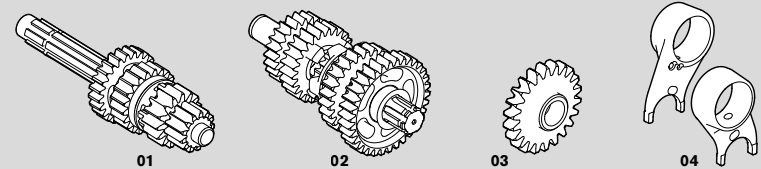

ARBRE BOÎTE PRIMAIRE COMPLET Ø 12 CÔTÉ ALLUMAGE Ø 14 CÔTÉ EMBR. LIFAN LONG. 155mm/ YX LONG. 153,5mm

COMPLETE MAIN BOX SHAFT Ø 12 IGNITION SIDE & Ø 14 CLUTCH SIDE LIFAN LENGTH 155mm/ YX LENGTH 153,5mm

- 01 N° E13K030 (YX)
- 01 N° A00K030 (88/ 125 SEMI-AUTO ET 125 POINT MORT)

ARBRE BOÎTE SECONDAIRE COMPLET Ø 17 CÔTÉ PSB LIFAN Ø 14 CÔTÉ ALLUMAGE/ YX Ø 15 CÔTÉ ALLUMAGE

COMPLETE SECONDARY BOX SHAFT Ø 17 PSB SIDE LIFAN Ø 14 IGNITION SIDE/ YX Ø 15 IGNITION SIDE

- 02 N° E13K040 (YX)
- 01 N° A00K040 (88/ 125 SEMI-AUTO ET 125 POINT MORT)

PIGNON INTERMÉDIAIRE EMBRAYAGE

INTERMEDIATE CLUTCH SPROCKET

- 03 N° 208-12-23N (YX : ÉPAISSEUR/ THICKNESS 14mm)

JEU DE FOURCHETTES DE BOÎTE RENFORCÉE

REINFORCED GEARBOX FORK

- 04 N° FBR

EMBRAYAGE CLUTCH



**EMBRAYAGE COMPLET DÉMARRAGE AU POINT MORT
START 2012-25**
COMPLETE CLUTCH NEUTRAL START
START 2012-25

N° EC



EMBRAYAGE COMPLET 88/125 SEMI-AUTO
COMPLETE CLUTCH 88/125 SEMI-AUTO

N° 21100L



EMBRAYAGE COMPLET POUR DÉMARRAGE EN PRISE
COMPLETE CLUTCH FOR KICKSTARTER ENGINE

N° 22100/152FMH
N° 100103297 (Zongshen fiddy racer 110/125)
N° 22000-JZ28-0000 (Zongshen 155)



COURONNE D'EMBRAYAGE 88/125 SEMI-AUTO
CLUTCH SPROCKET 88/125 SEMI-AUTO

N° 22610L - 69 TEETH (START SE 88/125)
N° A00K016 - 67 TEETH (LITE 88-125/ START 125)



DISQUE D'EMBRAYAGE YX
YX CLUTCH PLATE

01 N° 22330/152FMH (GARNI/ FRICTION)
02 N° 22341/152FMH (LISSE/ SMOOTH)



DEMI CARTER EMBRAYAGE 88/ 125
HALF CLUTCH COVER 88/ 125

N° RCSC-BK





JOINTS DE CARTER D'EMBRAYAGE
ENGINE CLUTCH COVER GASKET

01 N° E041B002 (START/ PILOT 125)
02 N° 11319/152FMH (125 - 140 - 150CRF)



JOINT SPY SÉLECTEUR
OIL SEAL SHAFT

01 N° 24190/152FMH

JOINT SPY KICK
KICKSTARTER OIL SEAL

02 N° F001C015 (KLX: 16X28X7)
02 N° F05C085 (CRF: 16X24X5)
02 N° 27190/152FMH (Ø 13mm)

JOINT SPY PSB
OIL SEAL FOR COUNTERSHAFT SPROCKET

03 N° 23790/152FMI (Ø 20 - 20/30/4.5)
03 N° 23790/152FMH (Ø 17 - 17/29/5)

JOINT SPY TIGE COMMANDE EMBRAYAGE
CLUTCH CONTROL OIL SEAL

04 N° 22840/152FMH

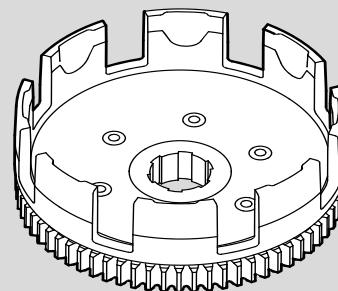

CLOCHE D'EMBRAYAGE
CLUTCH BELL

N° 22110/152FMH

PIGNON DE KICK
KICKSTARTER SPROCKET YX

02 N° 208K025 (YX)

PIGNON CLOCHE EMBRAYAGE
CLUTCH BELL SPROCKET

03 N° 208-12-25 (YX)

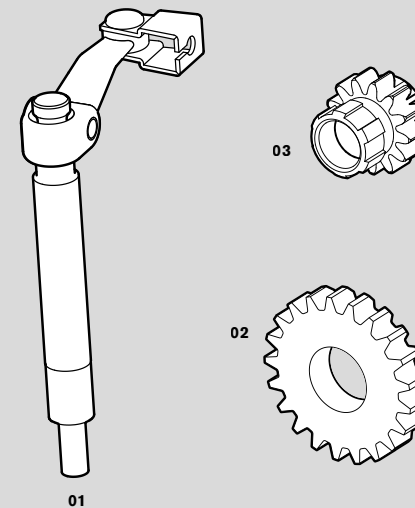

TIGE COMMANDE EMBRAYAGE
PUSH ROD

01 N° 22810/152FMH



ARBRE À CAME RACING POUR MOTEUR 140/150 YX
(PILOT/BIGY 150)
RACING CAMSHAFT FOR YX 140/150 ENGINE
(PILOT/BIGY 150)

N° Z40



CARBURATEURS CARBURETORS

NIBBI



CARBURATEUR NIBBI

NIBBI CARBURETOR

- 01 N° YC50-20-31 POUR MOTEUR 50cc
- 02 PZ18FL POUR MOTEUR 88cc
- 03 N° PE19FL POUR MOTEUR 125/150cc
N° PE24SP (SM125/SM150)
- 04 N° PE28SP POUR MOTEUR 190cc
- 05 N° NIBBI34

GICLEUR NIBBI CARBURATEUR PE GICLEUR PRINCIPAL / MAIN JET 88/90/92/95/98/100/102/105/108/110/112/115/118/120/122/125/128/130/132/135

06 N° LK-PE+TAILLE/SIZE

GICLEUR NIBBI CARBURATEUR PWK GICLEUR PRINCIPAL / MAIN JET 98/100/102/105/108/110/112/115/118/120/122/125/128/130/132/135/138/140/142/145/148

07 N° LK-PWK+TAILLE/SIZE

GICLEUR NIBBI CARBURATEUR PZ GICLEUR PRINCIPAL / MAIN JET 70/72/78/80/82/85/90/95/100

08 N° LK-PZ+TAILLE/SIZE

GICLEUR NIBBI CARBURATEUR PE/PWK GICLEUR RALENTI / SLOW JET 32/35/38/42/45/48/56

09 N° LK-FLK+TAILLE/SIZE

GICLEUR NIBBI CARBURATEUR PZ GICLEUR RALENTI / SLOW JET 32/35/38

10 N° LK-FLKZ+TAILLE/SIZE

NIBBI



KIT CARBURATEUR NIBBI 24

KIT CARBURETOR NIBBI 24

N° NIBBI24

KEIHIN



CARBURATEUR KEIHIN® PE28mm

PE28mm KEIHIN® CARBURETOR

N° 85707

MIKUNI



VIS DE CUVE MIKUNI®

MIKUNI® TANK SCREW

01 N° 16007L

VIS RICHESSE + RESSORT MIKUNI®

MIKUNI® NEEDLE VALVE + SPRING

02 N° 16005L

VIS RALENTI + RESSORT MIKUNI®

MIKUNI® IDLE SCREW + SPRING

03 N° 16006L

GICLEUR RALENTI MIKUNI® 10/ 15/ 17,5/ 20/ 22,5/ 25

MIKUNI® SLOW JET

04 N° GICLEUR+SIZE

GICLEUR PRINCIPAL MIKUNI® 85/ 90/ 92,5/ 95/ 97,5/ 100/ 102,5/ 105/ 107,5/ 110/ 115/ 120

MIKUNI® MAIN JET

05 N° GICLEUR+SIZE

POINTEAU CARBURATEUR

CARBURETOR FLOAT NEEDLE

- 06 N° FLON-50A (YCF50A)
- 07 N° FLON-CARBU22 (MIKUNI® 22)
- 08 N° 16008L (MIKUNI® 26)

AIGUILLE CARBURATEUR MIKUNI®

MIKUNI® CARBURETOR NEEDLE

09 N° 16004L

JOINT CUVE CARBURATEUR

CARBURETOR FLOAT BOWL GASKET

- 10 N° 16010L (MIKUNI® 26)
- 11 N° SEAL-CARBU22 (MIKUNI® 22)
- 12 N° SEAL-PE28 (KEIHIN® PE28)
- 13 N° SEAL-50A (YCF 50A)



PIPE ADMISSION DAYTONA®
DAYTONA® INLET PIPE

01 № 86404 (ANIMA)
№ 84387 (DT)

PIPE ADMISSION SANS BOÎTE À AIR
INLET PIPE WITHOUT AIRBOX

02 № 17311

PIPE ADMISSION POUR BOÎTE À AIR 2025
INLET PIPE FOR AIRBOX

03 № 17311-2 (POUR/ FOR FACTORY SPII)
03 № 17311-4 (POUR/ FOR PILOT 125)
03 № 17311-5 (POUR/ FOR PILOT 150)
03 № 17311-6 (POUR/ FOR PE28)
03 № 17311-6-01 (POUR BOÎTE À AIR/ FOR AIRBOX 2025)
03 № 17311-3 (POUR/ FOR FACTORY SPIII)

JOINT PAPIER PIPE ADMISSION
INLET PIPE PAPER GASKET

04 № 17332/152FMH01 (ENTRE LA PIPE D'ADMISSION ET LE CARBURATEUR/ BETWEEN INLET PIPE AND CARBURATOR)
04 № 17332 (ENTRE LA CULASSE ET LA PIPE D'ADMISSION/ BETWEEN CYLINDER HEAD AND INLET PIPE)

CALE PLASTIQUE PIPE ADMISSION
INLET PIPE PLASTIC HOLDER

05 № 17331/152FMH

FOR 50 ONLY



STARTER AU GUIDON POUR YCF50A
CHOKE LEVER FOR YCF50A

01 № YC50-0142-01



CAGE DE FILTRE À AIR
AIR FILTER CAGE

01 № YC110-08-012
02 № YC110-08-013

MANCHON DE BOÎTE À AIR YCF
YCF AIRBOX SLEEVE

03 № YC110-08-0171 (Ø 49 POUR/ FOR KEIHIN® PE28)
03 № YC110-08-017 (Ø 40)
03 № YC110-08-0173 (PILOT 125 2015-2020)
03 № YC110-08-0174 (PILOT 150 2016-2020/ SM150 2016-2020)
03 № YC110-0823-02 (BIGY 125 2021-25)
03 № YC110-0823-03 (SP3 2021-22 / BIGY 150 - 190 2021-25)
03 № YC110-0823-04 (PILOT 125 2021-25)
03 № YC110-0823-07 (PILOT 150 2021-25)



MANCHON SOUPLE
FLEXIBLE SLEEVE

01 № 17315 (VM 24)
02 № 46758 (POUR/ FOR DAYTONA®)



SURFILTRE À AIR (VENDU SANS FILTRE À AIR)
AIR FILTER PROTECTION (AIR FILTER NOT INCLUDED)

№ K130K (POUR FILTRE ORIGINE YCF/ FOR YCF ORIGINAL AIR FILTER)
№ K386K (POUR/ FOR TWIN AIR)

FILTRES À AIR AIR FILTERS

**NEW
2025**



NOUVELLE BOÎTE À AIR
NEW AIRBOX

N° YC110-0801-12-01 (POUR/ FOR PILOT/ FACTORY/ BIGY 2025)



KIT POUR BOÎTE À AIR
AIR FILTER CAGE

N° YC110-0841-01



FILTRE À AIR MOUSSE
FOAM AIR FILTER

- 01 N° TA-158430 (POUR/FOR AIR BOX PILOT/ FACTORY/ BIGY)
- 02 N° TA-158432 (Ø 40mm POUR/ FOR MIKUNI® 26mm)
- 03 N° TA-158431 (Ø 50mm POUR/ FOR KEIHIN® 28mm)



⚠ PIPE ADMISSION ADÉQUATE, VOIR PAGE 134
SUITABLE INLET PIPE, CHECK PAGE 134

NOUVELLE BOÎTE À AIR
NEW AIRBOX

- 01 N° YC110-0801-07 (POUR/ FOR PILOT 125 & 150, 2015-25)
- 02 N° YC110-08-02 (POUR/ FOR FACTORY 2012-25)
- 03 N° YC110-0801-09 (POUR/ FOR LITE/ START)



FILTRE À AIR MOUSSE
FOAM AIR FILTER

- 01 N° YC110-0802-03 (POUR/ FOR CARBU 22 mm)
(POUR FOR LITE/ START 88/ GP107)
- 02 N° YC110-0802-10 (POUR/ FOR CARBU 26 MIKUNI/
NIBBI PE19FL/ PE24SP)(POUR FOR LITE/ START 125/
SM 125/150)
- 03 N° YC110-0802-05 (POUR/ FOR CARBU KEIHIN/
NIBBI PE 28 mm)



FILTRE À AIR EN MOUSSE POUR BOÎTE À AIR
FOAM AIR FILTER FOR AIR BOX

N° YC110-0817-03-BL
(PILOT 2016-22/ FACTORY 2012-25/ BIGY)

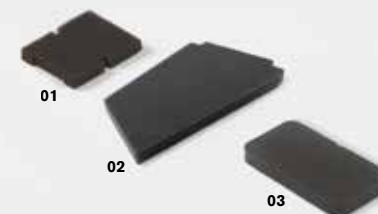

FILTRE À AIR EN MOUSSE POUR BOÎTE À AIR
FOAM AIR FILTER FOR AIR BOX

- 01 N° YC50-0802 (POUR/ FOR YCF 50)
- 02 N° YC110-0817-02 (POUR/ FOR LITE/ START)
- 03 N° YC110-0817-08 (POUR BOÎTE À AIR/ FOR AIRBOX 2025)

ÉCHAPPEMENTS EXHAUSTS



**SPECIAL PARTS
YCF RACING**

LAINÉ DE ROCHE POUR SILENCIEUX
MUFFLER PACKING FOR NOISE REDUCTION

01 N° LR1

BRIDE DE POT POUR SILENCIEUX
MUFFLER SPARK ARRESTOR

02 N° YC110-13-30

JOINT DE POT
EXHAUST SEAL

03 N° 18291/152FMH

EMBOUT DE POT 88/RS/RSP/SM 2011-2025
EXHAUST END FOR 88/RS/RSP/SM 2011-2025

04 N° YC110-13-32
08 N° YC110-13-35 (FACTORY)

RESSORT DE POT AVEC CAOUTCHOUC
EXHAUST SPRING WITH RUBBER

05 N° YC110-13-21

EMBOUT SILENCIEUX POUR LAVAGE MOTO
WASH MUFFLER PLUG

06 N° EEP-BL

BRIDE DE POT
SPARK ARRESTOR

07 N° BP30BLACK (Ø 30)



ATTACHE SILENCIEUX OVALE (88, RS, RSP, SM 2011-25)
OVAL MUFFLER CLAMP (88, RS, RSP, SM 2011-25)

N° YC110-13-06



ÉCHAPPEMENTS RACING RACING EXHAUSTS



FACTORY
SPECIAL PARTS
YCF RACING

LIGNE ÉCHAPPEMENT COMPLÈTE RACING SIMPLE
COMPLETE RACING EXHAUST SINGLE

N° YC110-136-07-BK (POUR/ FOR PILOT/ SM150)
N° YC110-139-07-BK (POUR/ FOR FACTORY)
N° YC110-140-01-BK (POUR/ FOR BIGY)



FACTORY
SPECIAL PARTS
YCF RACING

ATTACHE SILENCIEUX FACTORY
FACTORY MUFFLER CLAMP

N° YC110-1307-03



RESSORT DE POT FACTORY
FACTORY EXHAUST SPRING WITH RUBBER

N° YC110-13-22



FACTORY
SPECIAL PARTS
YCF RACING

SILENCIEUX RACING FACTORY
FACTORY RACING EXHAUST

N° YC110-13014-03BK



SILENCIEUX ANTI-BRUIT
SPARK ARRESTOR

N° YC110-13014-02-GY



FACTORY
SPECIAL PARTS
YCF RACING

LIGNE ÉCHAPPEMENT COMPLÈTE RACING DOUBLE
COMPLETE RACING EXHAUST TWIN

N° YC110-136-08-BK (POUR/ FOR PILOT/ SM150)
N° YC110-139-08-BK (POUR/ FOR FACTORY)
N° YC110-140-02-BK (POUR/ FOR BIGY)



COLLECTEUR RACING
RACING MID PIPE

N° YC110-1302-22 (PILOT)
N° YC110-1302-13 (SP3)
N° YC110-1308-01 (BIGY)



Y DU COLLECTEUR RACING DOUBLE
DOUBLE RACING MID PIPE Y

N° YC110-1302-23 (PILOT)
N° YC110-1302-14 (SP)
N° YC110-1308-03 (BIGY)



PARTIE INTERMÉDIAIRE COLLECTEUR RACING
RACING MID PIPE INTERMEDIATE PART

N° YC110-1302-24 (PILOT)
N° YC110-1302-15 (SP)
N° YC110-1308-02 (BIGY)



ÉCHAPPEMENT YCF ANTI-BRUIT (GAMME FACTORY)
SPARK ARRESTOR YCF EXHAUST (FACTORY RANGE)

N° YC110-139-03 (POUR/ FOR FACTORY SP2 & SP3)
N° YC110-139-09 (POUR/ FOR BIGY)



ÉCHAPPEMENT GROS DIAMÈTRE AVEC BRIDE DE POT AMOVIBLE
LARGE DIAMETER EXHAUST SUPPLIED WITH REMOVABLE SPARK ARRESTOR

N° YC110-136-GY (POUR/ FOR START)
N° YC110-136-03-GY (POUR/ FOR PILOT/ SM 150)
N° YC110-139-10 (POUR/ FOR BIGY)



COLLECTEUR ÉCHAPPEMENT FACTORY
FACTORY EXHAUST MID PIPE

N° YC110-13028-01 (SP3)
N° YC110-13028-03 (BIGY 190)
N° YC110-13028-05 (PILOT)
N° YC110-13028-02 (SP3 DOUBLE)
N° YC110-13028-04 (BIGY DOUBLE)
N° YC110-13028-06 (PILOT DOUBLE)



COLLECTEUR ÉCHAPPEMENT BIGY
BIGY EXHAUST MID PIPE

N° YC110-1302-20 (125/150 BIGY MX)
N° YC110-1302-28 (150 BIGY FACTORY)

FILTRES & RADIATEURS FILTERS & COOLERS



KIT COMPLET RADIATEUR HUILE
COMPLETE OIL COOLER KIT

N° YC110-2307 (DIAM 10/10 DAYTONA @/ YX150-5 (CRF))
N° YC110-2305 (DIAM 8/10 YX150-2 (KLX)/ ZONGSHEN 155-G/ ZONGSHEN 125-G



KIT RADIATEUR UNIVERSEL ADAPTABLE SUR TOUS LES MODELES
UNIVERSAL OIL COOLER KIT ADAPTABLE TO ALL MODELS

N° YC110-2306 (VENDU AVEC 6 DURITES/ SOLD WITH 6 HOSES)



PETITE JAUGE HUILE NOIRE/ BLEUE/ ROUGE/ VERTE/ ORANGE
LITTLE OIL DIPSTICK BLACK/ BLUE/ RED/ GREEN/ ORANGE

01 N° JH01-COLOR (SM150/ FACTORY/ BIGY FACTORY 150/190)



FILTRE À HUILE
OIL FILTER

01 N° 216E010
01 N° 14210-1038-0000 (110/125/155 ZONGSHEN FIDDY RACER)
LITE110R/ SM125/155/ PILOT 125 2022/ BIGY 125 2022-25

ÉPURATEUR D'HUILE ALLÉGÉ
FLYWHEEL

02 N° 208G082



DURITE HUILE RADIATEUR
OIL COOLER HOSE

N° YC110-23-01 (2007)
N° YC110-23-013 (L=400MM)
N° YC110-23-014 (L=285MM/ Ø=10)
N° YC110-23-015 (L=260MM/ Ø=8/8)
N° YC110-23-016 (L=125MM/ Ø=10/8)
N° YC110-23-017 (L=290MM/ Ø=10/10)
N° YC110-23-0003 (L=110MM/ Ø=10/8)
N° YC110-23-02 (2007)
N° YC110-23-022 (L=490MM)
N° YC110-23-023 (L=395MM/ Ø=10/8)
N° YC110-23-024 (L=495MM/ Ø=10/8)
N° YC110-23-025 (L=360MM/ Ø=10/10)

SPECIAL PARTS
YCF RACING



JAUGE HUILE NOIRE/ BLEUE/ ROUGE/ VERTE/ ORANGE/ VIOLET
OIL DIPSTICK BLACK/ BLUE/ RED/ GREEN/ ORANGE/ PURPLE

N° JH-COLOR (LITE/ START/ PILOT/ BIGY 125/150 MX)

SPECIAL PARTS
YCF RACING



BOUCHON VIDANGE AIMANTÉ
NOIR/ BLEU/ ROUGE/ VERT/ ORANGE/ VIOLET
MAGNETIC DRAIN PLUG
BLACK/ BLUE/ RED/ GREEN/ ORANGE/ PURPLE

01 N° BVE1-COLOR

HUBLOT À HUILE
OIL LEVEL SIGHT GLASS

02 N° D00C027

ALLUMAGE IGNITION



FAISCEAU ÉLECTRIQUE
WIRING HARNESS

- 01 N° YC110-1501 (NON ÉTANCHE/ NO WATERPROOF)
- N° YC110-1501-12 START SE 88/125 (CONNECTEUR ÉTANCHE/ WATERPROOF CONNECTION)
- N° YC110-1501-08 BIGY (DÉMARREUR ÉLECTRIQUE/ ÉLECTRIC START/ CONNECTEUR ÉTANCHE/ WATERPROOF CONNECTION)
- N° YC110-1501-09 BIGY (SANS DÉMARREUR/ WITHOUT ÉLECTRIC START CONNECTEUR ÉTANCHE/ WATERPROOF CONNECTION)
- N° YC110-1501-11 (LITE/START/PILOT/SP) (SANS DÉMARREUR/ WITHOUT ÉLECTRIC START CONNECTEUR ÉTANCHE/ WATERPROOF CONNECTION)

BOÎTIER CDI
CDI BOX

- 02 N° YC110-1503

BOBINE HAUTE TENSION
HIGH TENSION IGNITION COIL

- 03 N° YC110-1504

BATTERIE
BATTERY

- 04 N° YC110-1507-02 (88 & 125SE)
- 04 N° YC110-1507-04 (BIGY)



CDI RACING
CDI RACING

- N° YC110-1503-01



FOR 50A ONLY



ALLUMAGE YCF
YCF IGNITION

- 01 N° YC50-1502 (RÉGULATEUR DE TENSION/ TENSION REGULATOR)
- 02 N° YC50-1510 (RELAIS DÉMARREUR/ STARTER RELAY)
- 03 N° YC50-1507-01 (BATTERIE POUR 50A/ BATTERY FOR 50A)
- 04 N° YC50-1514 (CHARGEUR BATTERIE/ BATTERY CHARGER)
- 05 N° YC110-1564 (CONTACTEUR À CLÉ AVEC LE SUPPORT/ WATERPROOF KEY SWITCH)
- 06 N° 82200-D083-000151 (DÉMARREUR 88/ 125SE)
- 07 N° YC50-20-66 (DÉMARREUR 50A)
- 08 N° YC110-1563-01 (SHUNT ÉTANCHE/ SHUNT WATERPROOF)



ALLUMAGE
MAGNETO

- 01 N° RRG-04 (ÉTANCHE-WATERPROOF)
- 02 N° 31100/152FMH
- 03 N° 31210/152FMH (PRISE ÉTANCHE)
- 04 N° 82120-G011-30534 (START SE)





COUPE CIRCUIT
REMOTE SWITCH

- 01 N° YC110-0105-01 (SWITCH ON/OFF)
- 02 N° YC110-0105 (SWITCH)
- 03 N° YC110-0105-21(SWITCH-WATERPROOF)
- 07 N° YC110-0139-03 (BOUTON DÉMARREUR/ START SWITCH)
- 08 N° YC110-0105-07 (POUR MOTEURS DAYTONA/ FOR DAYTONA ENGINES)
- 09 N° YC110-0105-08 (TOUS LES MODÈLES SAUF AVEC MOTEURS DAYTONA/ ALL MODELS EXCEPT DAYTONA ENGINES)

COMPTEUR D'HEURE & SUPPORT
HOUR METER & SUPPORTING PLATE

- 04 N° STANDCOMPT-H (SUPPORT/SUPPORTING PLATE)
- 05 N° COMPT01-H (COMPTEUR D'HEURE VIBRATION/ HOUR METER)
- 06 N° COMPT02-H (COMPTEUR D'HEURE ET COMPTE TOURS/ HOUR METER AND TACHOMETER)



COUPE CIRCUIT À DISTANCE
VENDU AVEC 2 TÉLÉCOMMANDES

DISTANCE ENGINE CUT OFF
SOLD WITH 2 REMOTES CONTROL

N° YC50-1518



BOUGIE & ANTI PARASITE
SPARK PLUG & SPARK PLUG CAP

- 01 N° 221D021 SP3/ BIGY 190/ BIGY 190 XL/ SUNDAY 187/ GP 187 (4 SOUPAPES YX/ YX 4 STROKE)
- 02 N° 34210/152FMH YCF 50A/ START 125/ PILOT/ SP2 / BIGY MX/ BIGY 150 FACTORY/ GP 124/ GP 157 (CR7HS)
- 03 N° 34210/D8EA LITE/ START 88SE/ START 125SE
- 04 N° YC110-1505 (CAP/ ANTI PARASITE)



DAYTONA® ANIMA®
RACING PARTS/PIECES RACING



CHAÎNE DE DISTRIBUTION RENFORCÉE D.I.D
D.I.D REINFORCED TIMING CHAIN

N° 87577



PISTON FORGÉ POUR ANIMA®
FORGED PISTON FOR ANIMA®

N° 87173 (150cc)
N° 88599 (190cc)



KIT ARBRE À CAME RACING
RACING CAMSHAFT KIT

N° 87583



KIT 212cc
212cc KIT

N° 88011



KIT ALLUMAGE F-SM RÉGLABLE
MULTI CURVES ROTOR KIT

N° 87235



**COUVRE FILTRE HUILE ANIMA® NOIR/ BLEU/ ROUGE/
VERT/ ORANGE/ VIOLET**

ANIMA® OIL FILTER COVER BLACK/ BLUE/ RED/ GREEN/
ORANGE/ PURPLE

N° OFCDAYT-COLOR



COUVRE CULASSE ANIMA® RACING
ANIMA® RACING CYLINDER HEAD COVER

N° 87994



PIPE ADMISSION ANIMA® 15°
INTAKE MANIFOLD ANIMA® 15°

N° YC110-2012-01



CHAÎNE DE DÉMARREUR RENFORCÉE DID
STARTER CHAIN DID

N° 89522

DAYTONA®

DAYTONA® ANIMA® 2,0 150/ 190cc (4 VALVES) GENUINE PARTS/ PIÈCES D'ORIGINES

DAYTONA

SEQ #	PART #	DESCRIPTION	QTY
1	86461	BOLT, CROSS RECESSED COUNTERSUNK M6x15	2
2	86464	BOLT, HEXAGON FLANGE M6x25	2
3	86472	BOLT, HEXAGON FLNAGE M6x32	1
4	87349	BOX, CDI, DESIGNATION FDX	1
4	89373	BOX, CDI FSM-SYS 2024	1
5	86426	COIL, IGNITION	1
6	86373	COVER, MAGNET	1
7	89678	FLYWHEEL MAGNET COMP FDX	1
7	88127	FLYWHEEL MAGNET COMP FSM-SYS 2024	1
8	86452	NUT, MAGNET M12	1
9	86479	O-RING, Ø6,5xØ1,8	2
10	86916	STATOR ASSY, DESIGNATION FDX	1
10	88129	STATOR ASSEMBLY FSM	1
10	80744	STATOR ASSY, SYS 2024	1
11	86428	WIRE HERNESS	1

DAYTONA

SEQ #	PART #	DESCRIPTION	QTY
1	84678	BOLT, CROSS RECESSED COUNTERSUNK M6x30	1
2	84677	BOLT, CROSS RECESSED COUNTERSUNK M6x35	2
3	84676	GASKET, PUMP OIL	1
4	83747	PIN, DOWEL Ø8xØ6,3x12	2
5	86382	PUMP, OIL ASSY	1

DAYTONA

SEQ #	PART #	DESCRIPTION	QTY
1	86446	BOLT, BANJO M10x22,5	2
2	86362	BOLT, HEXAGON FLANGE M6x105	1
3	86486	BOLT, HEXAGON FLANGE M6x15	2
4	86469	BOLT, HEXAGON FLANGE M6x22	2
5	86485	BOLT, HEXAGON FLANGE M6x28	2
6	86471	BOLT, HEXAGON FLANGE M6x30	2
7	86473	BOLT, HEXAGON FLANGE M6x50	2
8	86474	BOLT, HEXAGON FLANGE M6x55	1
9	83759	BOLT, HEXAGON FLANGE M6x60	1
10	86361	BOLT, HEXAGON FLANGE M6x90	1
11	86376	COVER, CLUTCH	1
12	86374	COVER, OIL FILTER	1
13	86377	COVER, SMALL CLUTCH	1
14	83489	FILTER, OIL	1
15	86437	GASKET, COVER CLUTCH	1
16	86476	GASKET, M10	4
17	86412	HOLDER, CABLE CLUTCH	1
18	86414	LEVER, CLUTCH COMP	1
19	86432	O-RING, Ø38,6x2,6	1
20	86435	O-RING, COVER SMALL CLUTCH	1
21	86441	OIL SEAL, Ø16xØ26x7	1
22	86442	OIL SEAL, Ø17xØ10x5	1
23	86406	OIL THROUGH COMP	2
24	83747	PIN, DOWEL Ø8xØ6,3x12	4
25	86386	RULER	1
26	86413	SPRING, LEVER CLUTCH	1
27	86375	SPRING, OIL FILTER	1
28	86475	WINDOW, OIL LEVEL	1

DAYTONA



ALLUMAGE GENERATOR

ANIMA® 2,0 150/ 190CC

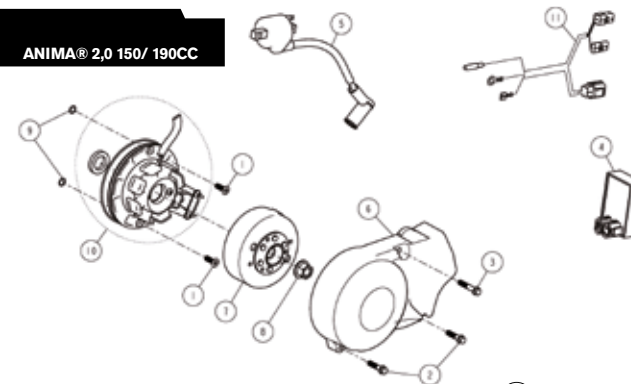

POMPE À HUILE OIL PUMP

ANIMA® 2,0 150/ 190CC

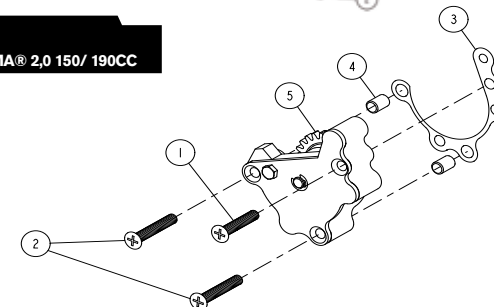

CARTER EMBRAYAGE COVER CLUTCH

ANIMA® 2,0 150/ 190CC

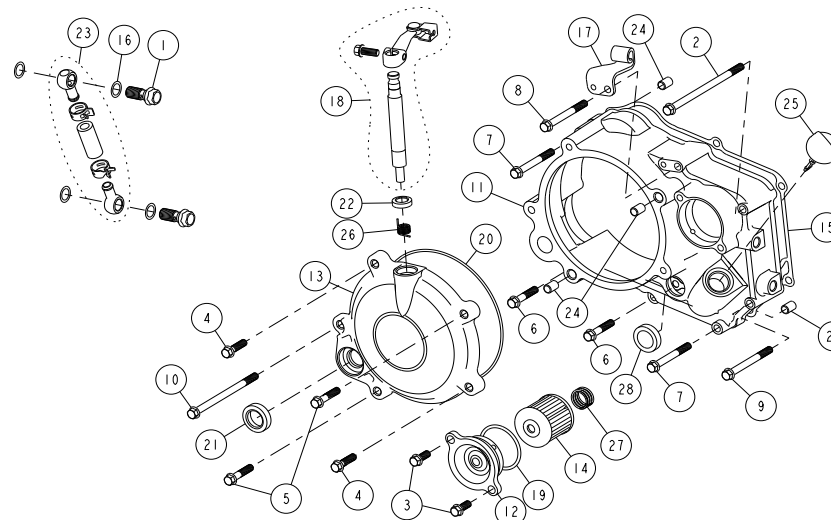

DAYTONA

SEQ #	PART #	DESCRIPTION	QTY
1	86453	CLIP, PIN PISTON	2
2	86381	CRANK SHAFT ASSY ANIMA 150	1
3	86620	CRANK SHAFT ASSY ANIMA 190	1
3	87760	CRANK SHAFT ASSY ANIMA 160	1
3	89144	CRANK SHAFT ASSY ANIMA 190-5 SPEEDS	1
3	80601	CRANK SHAFT ASSY ANIMA 190 SYS 2024	1
4	86383	GEAR, OIL PUMP DRIVE	1
5	86415	GEAR, PRIMARY DRIVE	1
6	83768	NUT, SMALL M14	1
7	86443	OIL SEAL, Ø12xØ20x5t	1
8	86379	PIN, PISTON Ø14	1
8	89978	PIN PISTON L=39 SYS 2024	1
9	86378	PISTON DT150	1
10	86621	PISTON DT190	1
10	80316	PISTON 190 SYS 2024	1
11	86462	RETAINING RING, RTWN22	1
12	86380	RING SET, PISTON	1
12	89977	RING SET, PISTON 66MM-SYS 2024	1
13	86411	WASHER, SPRING	1

DAYTONA

PISTON & VILEBREQUIN
PISTON & CRANK SHAFT

ANIMA® 2,0 150/ 190CC

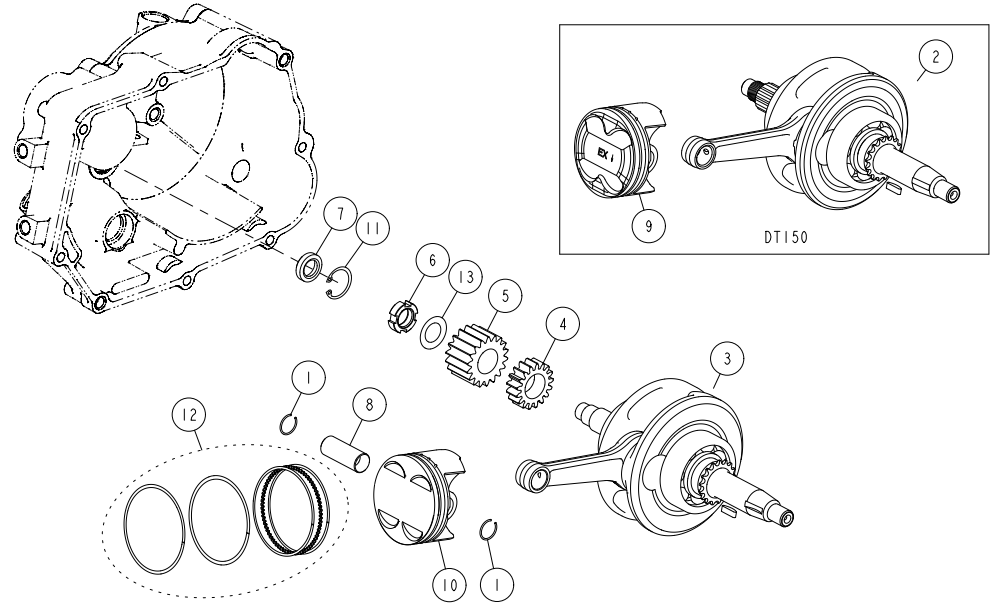

DAYTONA

SEQ #	PART #	DESCRIPTION	QTY
1	86474	BOLT, HEXAGON FLANGE M6x55	1
2	83761	BOLT, HEXAGON FLANGE M6x65	1
3	86360	BOLT, HEXAGON FLANGE M6x70	5
4	86459	BOLT, HEXAGON SOCKET M6x105	2
5	83755	BOLT, OIL DRAIN M12x15	1
6	86444	BOLT, STUD A	2
7	86445	BOLT, STUD B	2
8	86369	COVER, STRAINER OIL	1
9	86370	CRANK CASE, LH	1
9	89143	CRANK CASE, LH, 5 SPEEDS	1
10	86884	CRANK CASE, RH	1
10	88848	CRANK CASE, RH, 5 SPEEDS	1
11	86438	GASKET, CRANKCASE	1
12	86371	HOSE, BREATHER	1
13	86451	NUT FLANGE, M8	4
14	86433	O-RING, Ø30xØ3	1
15	83720	PIN, DOWELØ10xØ8,4x14	2
16	86385	SPRING, STRAINER	1
17	86387	STRAINER, OIL	1
18	86457	WASHER, GASKET M8	4
19	83754	WASHER, OIL DRAIN M12	1

CARTER
CRANKCASE

ANIMA® 2,0 150/ 190CC

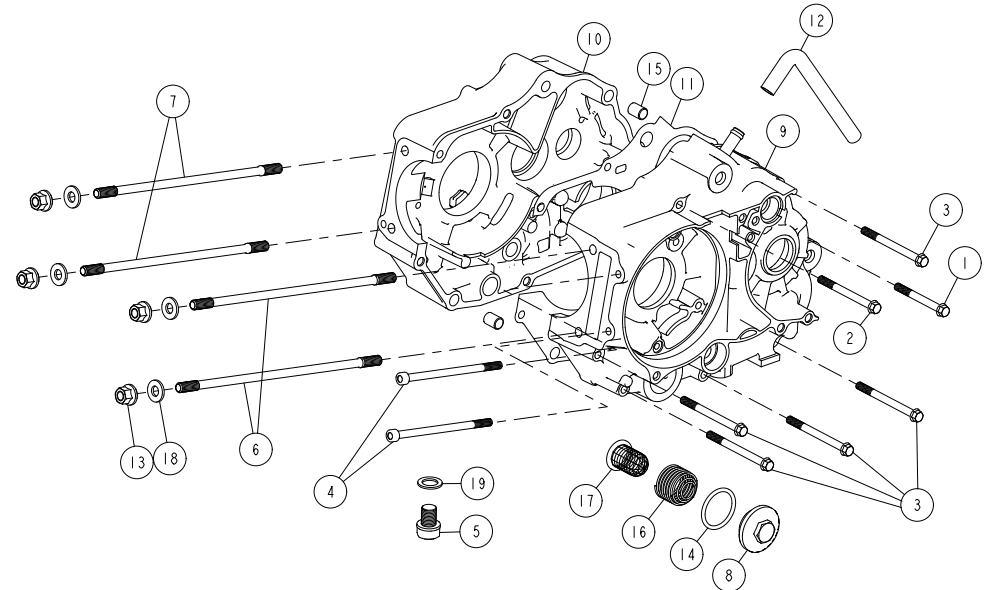

SEQ #	PART #	DESCRIPTION	QTY
1	86448	BOLT, HEXAGON FLANGE M10x16	1
2	85877	BOLT, HEXAGON FLANGE M6x12	1
3	86468	BOLT, HEXAGON FLANGE M6x18	6
4	86466	BOLT, HEXAGON FLANGE M6x25	1
5	86471	BOLT, HEXAGON FLANGE M6x30	1
6	83703	BOLT, STUD M6x32	2
7	86367	COVER, CYLINDER HEAD	1
8	86366	CYLINDER	1
8	87975	CYLINDER 190 SYS 2024	1
9	89458	GASKET,BASE CYLINDER 190 SYS 2024	1
9	86436	GASKET, BASE CYLINDER	1
10	86440	GASKET, HEAD CYLINDER	1
11	86476	GASKET, M10	1
12	86405	GASKET, MANIFOLD	1
13	86439	GASKET, TANSIONER CAM CHAIN	1
14	86368	HEAD, CYLINDER	1
15	86404	MANIFOLD, INTAKE	1
16	86479	O-RING	1
17	86434	O-RING, COVER HEAD	1
18	83720	PIN, DOWEL Ø10xØ8,4x14	4
19	83747	PIN, DOWEL Ø8xØ6,3x12	1
20	221D021	SPARK PLUG ER9EH	1
21	86396	TENSIONER, CAM CHAIN COMP	1
22	86456	WASHER, Ø6,3xØ12x1,5	1

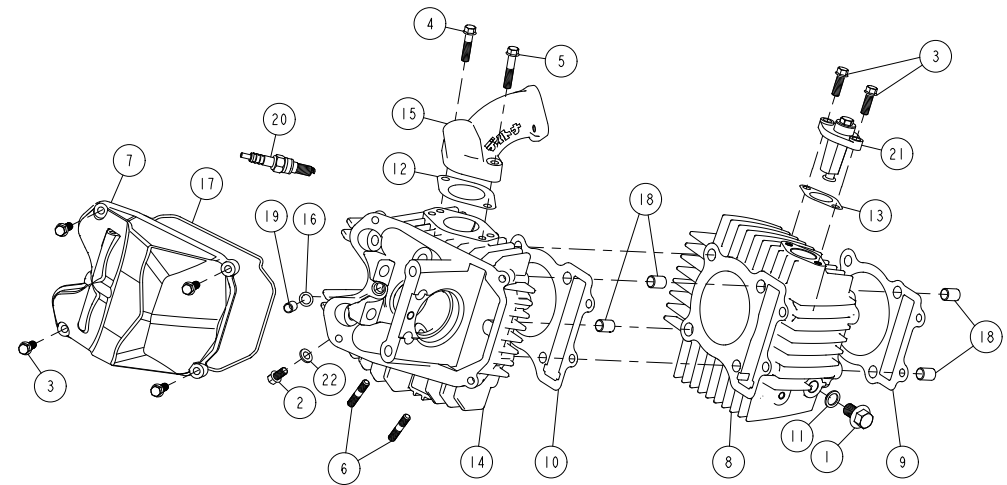

SEQ #	PART #	DESCRIPTION	QTY
1	86481	ARM, ROCKER ROLLER EXHAUST COMP	1
2	86393	ARM, ROCKER ROLLER INTAKE COMP	1
3	86460	BOLT, COUNTERSINK M6x15	1
4	86883	SCREW M6X16	2
5	86447	BOLT, TENSIONER	1
6	86878	CAMSHAFT 240Ø ROLLER DECOMP ASM	1
7	86391	CHAIN, CAMSHAFT DRIVE	1
8	86402	COTTER, VALVE	8
9	89681	SHAFT W/WEIGHT,DECOMP,V3	1
10	86395	GUDE , CHAIN CAMSHAFT	1
11	86389	PLATE, STOPPER CAM	1
12	86400	RETAINER, SPRING VALVE	4
13	86403	SEAL, VALVE STEM Ø4.5	4
14	86401	SEAT, SPRING VALVE	4
15	86392	SHAFT, ROCKER	2
16	87621	SPRING,RETURN DECOMP.	1
17	86624	SPRING, VALVE	4
18	86879	SPROCKET, CAMSHAFT DRIVEN	1
19	87620	PLATE,STOPPER DECOMP.	1
20	86394	TENSIONER, CAM CHAIN	1
21	86623	VALVE, EXHAUST Ø21	2
22	86397	VALVE, INTAKE Ø24.5	2

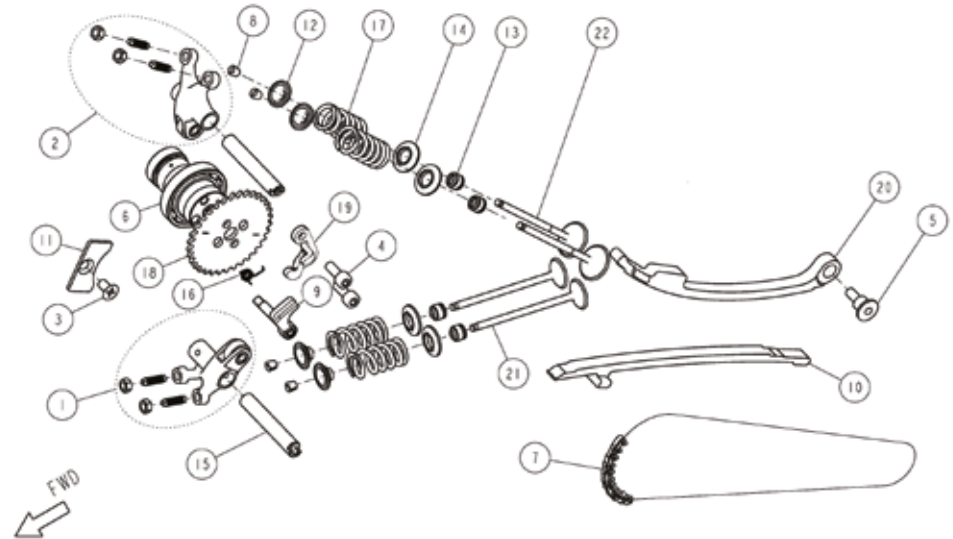

DAYTONA

DAYTONA

**EMBRAYAGE
CLUTCH**

ANIMA® 2,0 150/ 190CC

SEQ #	PART #	DESCRIPTION	QTY
1	83786	BEARING, #6000	1
2	87619	CLUTCH COMP (FORGED GEAR)	1
3	86417	GEAR, STARTER DRIVEN 2 13T	1
4	83768	NUT, SMALL M14	1
5	83787	PIN, LIFTER CLUTCH	1
6	86410	WASHER, SPRING Ø24xØ14,2x1,2 1	1

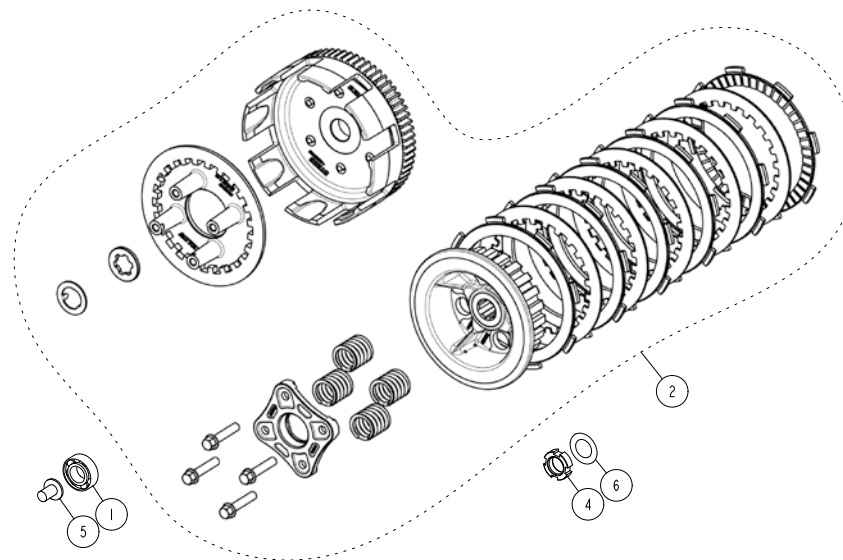

DAYTONA

**BOÎTE DE VITESSE
GEARBOX**

ANIMA® 2,0 150/ 190CC

SEQ #	PART #	DESCRIPTION	QTY
1	83788	BEARING #6001	1
2	83795	BEARING #6203	2
3	86454	BEARING NK152712	1
4	86464	BOLT, HEXAGON SOCKET M6x10	2
5	86418	GEAR IDLE, STARTER	1
6	86919	GEAR, COMP,4 SPEED	1
6	89682	GEAR, COMP 5 SPEED	1
7	83796	OIL SEAL, Ø29xØ17x5	1
8	86420	PLATE, FIXING SPROCKET DRIVE	1
9	86463	RETAINING RING Ø13,6	1
10	86419	SPROCKET, DRIVE 15T	1
11	86455	WASHER, Ø22xØ15x0,5	2

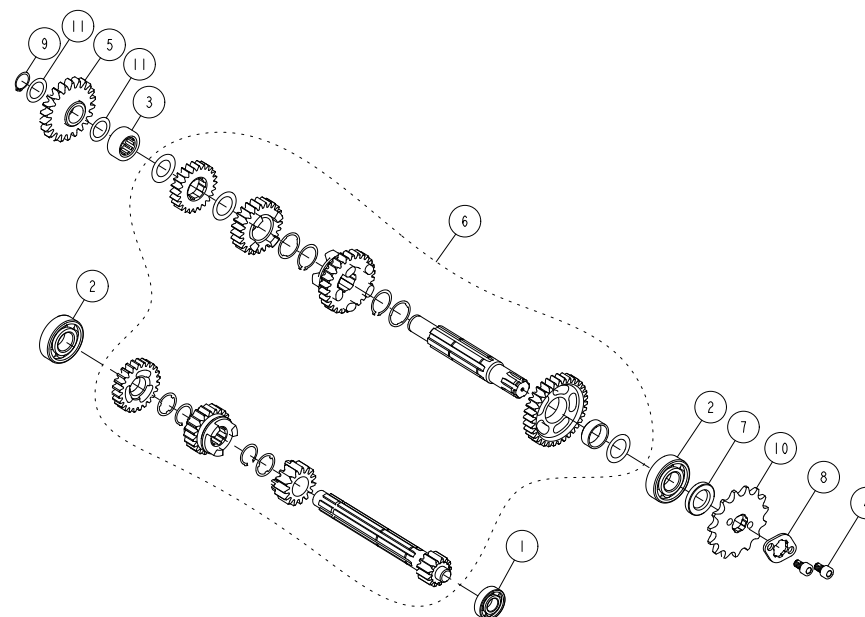

SEQ #	PART #	DESCRIPTION	QTY
1	86449	BOLT, HEXAGON SOCKET M6	1
2	85877	BOLT, HEXAGON SOCKET M6x15	1
3	83833	CONTACT, GEAR INDICATION	1
4	86421	DRUM, SHIFT N-1-2-3-4 COMP	1
4	88423	DRUM, SHIFT 5 SPEEDS	1
6	86422	LEVER, GEAR SHIFT COMP	1
6	88886	LEVER, GEAR SHIFT COMP 5 GEAR	1
7	86424	LOCATING PLATE UNIT	1
8	83837	OIL SEAL, Ø24xØ16x10	1
9	86480	PIN, LOCATING SHIFT LEVER	1
10	85876	PLATE, LOCATING SWITCH NEUTRAL	1
11	86423	SPRING, LOCATING PLATE	1

**BOÎTE/ FOURCHETTES
GEARBOX MECHANISM**

ANIMA® 2,0 150/ 190CC

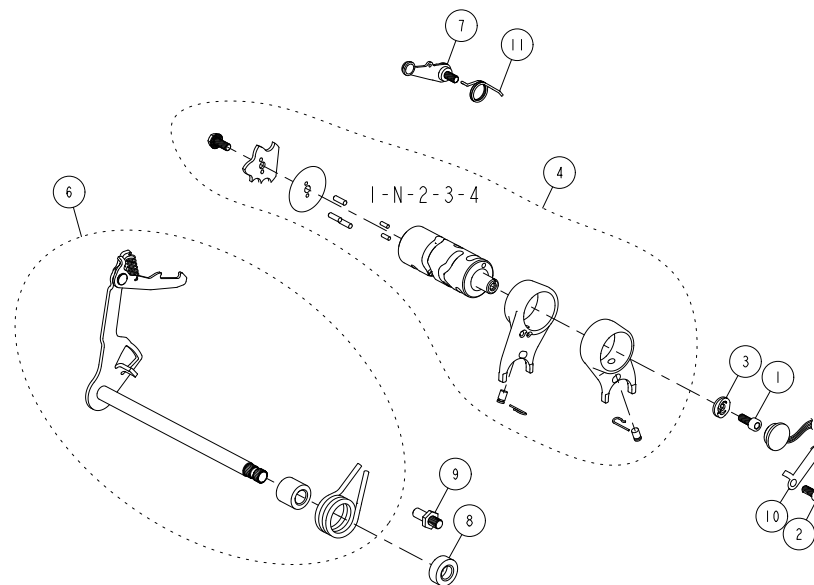

SEQ #	PART #	DESCRIPTION	QTY
1	86407	KICK STARTER ASM	1
1	88883	KICK ASSY 5 GEAR	1

**KICK
KICK STARTER**

ANIMA® 2,0 150/ 190CC

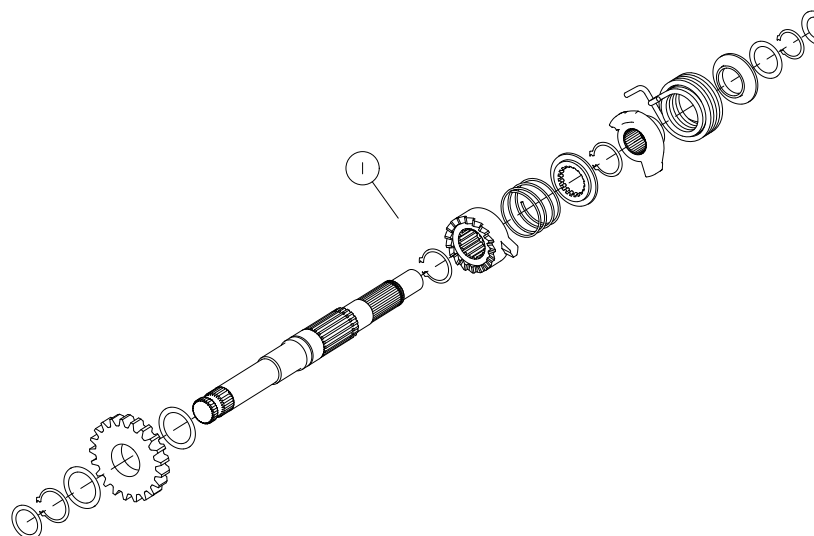

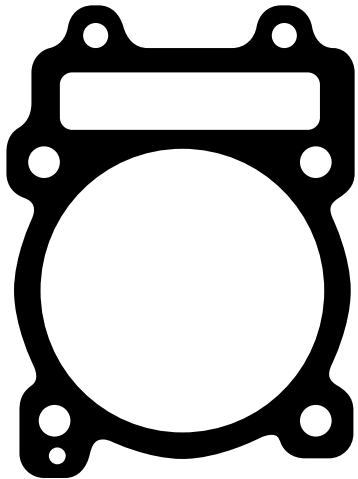

ART DIRECTION

ENCORE STUDIO

GRAPHIC DESIGN

F. ALAUX, T. JUMIN & Q. BRACHET

INDUSTRIAL DESIGN

FRANÇOIS ALAUX FOR YCF MOTORCYCLES

THANKS TO

#111

STEPHANE LE CORRE, CATHERINE HOSSARD & YCF CREW MEMBERS

BENJAMIN COISY/ JEAN GALLARDO/ EVAN GINEFRI/ VICTOR COISY

JUSTIN WABLE/ GEOFFROY DEHAYE

TRACK

DOMAINE DE PREFAISSAL

CIRCUIT DE LESSAY



WELCOMETOENCORE.COM

PHOTOGRAPHY

ACTION & STUDIO: JEAN-FRANÇOIS MUGUET

PARTS: ANTOINE CADOT

YCF FOUNDERS

DIMITRI BERA & YANNICK COQUARD



ENJOY YOUR RIDE

YCF



YouTube f t i

ALLE VORGESTELLTEN MODELLE ERFÜLLEN DIE EG-NORMEN. FAHRZEUGE SIND AUF ÖFFENTLICHEN STRASSEN NICHT ZUGELASSEN. NUR FÜR DEN GEBRAUCH AUF GESCHLOSSENEN UND PRIVATEN STRECKEN VORBEHALTEN. TRAGEN SIE IMMER HELM, SCHUTZBRILLE UND ANGEPASSTE SCHUTZAUSRÜSTUNG. FAHREN SIE NIEMALS MIT EINEM BEIFÄHRER.

YCF BEHÄLT SICH DAS RECHT VOR, DIE SPEZIFIKATIONEN ODER DIE PREISE SEINER PRODUKTE ZU ÄNDERN. JEDE VOLLSTÄNDIGE ODER TEILWEISE REPRODUKTION DIESES KATALOGS ERFORDERT DIE VORHERIGE ZUSTIMMUNG VON YCF.

www.ycf-riding.de